



Pearl[®]

2020 GENERAL CATALOG

Masterworks

Masterworks

Pearl



p. 2-9

MASTERWORKS

A custom tailored heirloom instrument for the drummer who wants ultimate control.
SHELL RECIPE: Choice/Combination of Birch, Maple, Gum, and/or Mahogany.
SOUND: Any desired sound is possible; you decide!



p. 10-11

REFERENCE

Individually engineered with premium Masterworks materials for articulate power and projection.
SHELL RECIPE: Reference Recipe Birch, Maple, and Mahogany hybrid.
SOUND: Enhanced output, cutting highs, powerful lows.



p. 26-27

SESSION STUDIO SELECT

Radically unique from Stage to Studio, blending pre-EQ'd warmth and articulate punch.
SHELL RECIPE: EvenPly-Six Birch (4-ply outer), African Mahogany (2-ply inner).
SOUND: Deep, rich bass frequencies. Top-end tonal spike.



p. 28-29

CRYSTAL BEAT

The original seamless Acrylic drum shell creates a striking visual and sonic showcase.
SHELL RECIPE: 7mm Seamless Molded Acrylic.
SOUND: Loud and immediate, delivers pummeling straight tone and yielding feel.



p. 12-13

REFERENCE PURE

Reference Recipe shell engineering in a lighter format for increased body and sustain.
SHELL RECIPE: EvenPly Birch, Maple, and Mahogany hybrid.
SOUND: Expressive, open tonality with responsive bottom-end boost.



p. 20-21

MASTERS MAPLE RESERVE

The vintage flair of the original Masters sound for a refined playing experience.
SHELL RECIPE: 4-ply Maple w/4-ply Reinforcement Rings.
SOUND: Balance of powerful midrange and smooth resonant attack.



p. 30-31

DECADE MAPLE

Premium gear for the evolving drummer, featuring lacquered, all Maple shells and pro level elements.
SHELL RECIPE: EvenPly-Six, 5.4mm Maple.
SOUND: Full Maple tone with lively midrange and smooth sustain.



p. 32-33

EXPORT / EXPORT LACQUER

The Best Selling Drum Set of All Time gives the student drummer a strong beginning.
SHELL RECIPE: 6-ply 7.5mm Poplar and Asian Mahogany hybrid.
SOUND: Crisp attack with dark, formidable bottom-end vibrance.



p. 22-23

MASTERS MAPLE GUM

Vital, recording optimized tone derived from the Masterworks: Studio shell recipe.
SHELL RECIPE: EvenPly-Six Maple (4-ply outer) and Gum (2-ply inner)
SOUND: Explosive midrange, full low-end, precise decay.



p. 24-25

MASTERS MAPLE COMPLETE

A road ready sonic powerhouse with inspired custom appointments.
SHELL RECIPE: EvenPly-Six, 5.4mm North American Maple
SOUND: Booming projection with equalized Low/Mid/High frequency mix.



p. 34

MIDTOWN

An ultra portable shell pack for full sized play and powerful grooves in a small footprint.
SHELL RECIPE: 6-ply 7.5mm Poplar.
SOUND: Tight, responsive tonal bite with enough bottom to fill the pocket.



p. 35

ROADSHOW

A drum set package complete with everything needed to kickstart your rhythmic journey.
SHELL RECIPE: 9-ply 7mm Poplar.
SOUND: Piercing, open cut with full sub-bass rumble.

DRUM SETS	DRUM SETS	ELECTRONIC SERIES	SNARE DRUMS	HARDWARE	HARDWARE	PERCUSSION	PERCUSSION
2-9 Masterworks	26-27 Session Studio Select	36-37 e/MERGE	43 Series Component	52-53 Demon Drive / Chain	63 Drum Thrones	71 Percussion Artists	80-81 Concert / Hand Percussion
10-11 Reference	28-29 Crystal Beat	38-39 MIMIC PRO	44 Free Floating	54-55 Eliminator Redline	64-65 Cymbal Stands	72-73 Congas & Bongos	82 Percussion Stands
12-13 Reference Pure	30-31 Decade Maple	38-39 malletSTATION	45 Hybrid Exotic	56-57 Eliminator Solo	66-68 Racks / Accessories	74-75 Cajons & Accessories	83 Bags, & Holders
14-19 Music City Custom	32-33 Export / Lacquer		46-47 SensiTone / Premium	58-59 P930 / P932	69 Tom Stands / Arms	76 Timbales / Cowbells	PARTS, ARTISTS, CONFIGS
20-21 Masters Maple Reserve	34 Midtown	SNARE DRUMS	48-49 Signature	59 P530 / P830	PERCUSSION	77 Rainsticks / Tongue Drums	84-87 Replacement Parts
22-23 Masters Maple Gum	34 Compact Traveler	40-41 MCC Solid Shell	50 Modern Utility	60-61 Hi-Hat Stands	70 Signature Series	78-79 Djembes	88-91 Pearl Artists
24-25 Masters Maple Complete	35 Roadshow / Jr.	42 Reference	51 Utility & Effects	62 Snare Stands	71 Travel Congas / Bongos	78-79 Folkloric / Brazilian	92-BACK Config. & Color Chart



HANDCRAFTED TO INSPIRE

A Masterworks drum set is a timeless expression; custom tailored with heirloom precision to elevate your drumming persona, and fully reflect your musical identity.

DRUMMING WITHOUT LIMITS

Selecting the right combination of our finest hand selected shell veneers with the precision engineering of our premium hardware appointments, Masterworks gives you the freedom to customize a sound that is completely your own.



MASTERWORKS CUSTOM KIT IN ROOTBEER GLOSS FADE OVER ARTISAN EXOTIC BURL MAHOGANY VENEER WITH BLACK NICKEL HARDWARE

DRUM SHELL TONE WOODS

Each of our premium shell materials has its own sonic signature that greatly affects the overall sound of each drum.



MAPLE
The perfect blend of tone, attack, and body. Equal tonal amounts of highs, mids, and lows.

BIRCH
"Built-in EQ" delivers articulate stroke with shorter, even decay. Boosted highs and mellow mid-level tone.

AFRICAN MAHOGANY
Deep, powerful punch with dark, elegant tone. Bottom end emphasis with beautifully smooth midrange sustain.

GUMWOOD
Explosive projection and increased volume. As a core or interior ply, Gum enhances tone in surrounding plies.

CUSTOM INTERIOR
The Ultimate Hybrid. Choose any of Pearl's Artisan Exotic exterior hardwoods, hand applied carbon fiber, or a thin layer fiberglass for boutique tones and visuals.

SHELL SIZE AND THICKNESS

For precise tonal character, sustain, and projection.

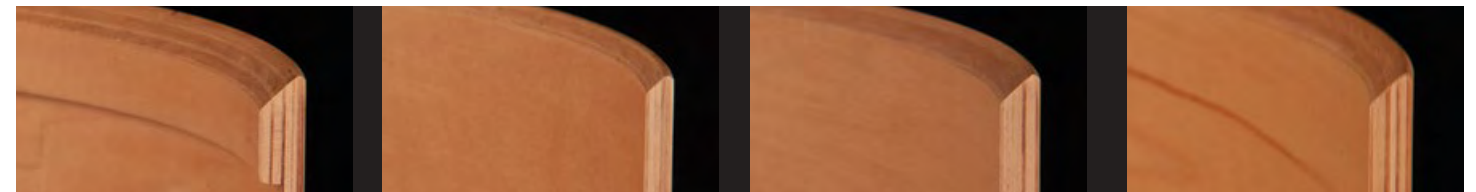

THIN (4-ply, 5mm w/ 4-ply Reinforcement Rings) Increased sustain and low-end.

MEDIUM (EvenPly-6, 5.4mm) Expanded tonal purity and resonant punch.

STANDARD (6-ply, 7.5mm) Full-bodied tonal projection ideal for general purpose.

THICK (8-ply, 10mm and 10-ply, 12.5mm) Maximum projection and quick decay.

FINISHES

CRAFT a personalized visual statement with drums hand finished and configured to your specifications.

LUXURY - Includes a choice of High Gloss, Satin Stain, and Sparkle Lacquer.

CUSTOM - Includes Pinstriping, Banding, Artisan II Custom Graphics.

ARTISAN - Choose from a selection of Exotic veneers (below) or hand applied Carbonply.



CAMEROON BLACK LIMBA

FLAME MAPLE

AFRICAN ZEBRA WOOD

TAMO ASH

WATERFALL BUBINGA

EUCALYPTUS

BURL MAHOGANY

CARBONPLY

BEARING EDGE

Masterworks offers a choice of five sonically tested edges - configurable by drum, application, and shell side.



STANDARD 45°
Provides the perfect blend of attack and warmth.

OUTER 60°
Pulls brighter overtones and increases punch.

INNER 45° Edge apex focused to inner shell plies for controlled sustain.

ROUNDED 45° Increased head-to-shell contact boosts mids and highs.

FULLY ROUNDED
Boosts mid-to-low range response and reduces decay.

HARDWARE FINISH, LUG, AND HOOP OPTIONS

LUGS

- Bridge (CL100)
- Single Swivel (STL100)
- Swivel Tube (STL150)
- Swivel Arch (BRL100)

FINISHES



CHROME (Shown w/ CL100 Lug)



NICKEL (Shown w/ STL100 Lug)



GOLD (Shown w/ STL150 Lug)

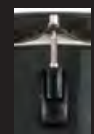

BLACK CHROME (Shown w/ BRL100 Lug)



BLACK NICKEL (Shown w/ STL150 Lug)

HOOPS



MASTERCAST DIE-CAST



2.3MM SUPERHOOP II

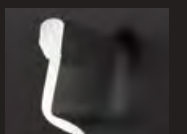

FATTONE

THE **EST** DIFFERENCE - *The Ultimate in Strength, Resonance, and Tone.*
Superior Shell Technology

Using the world's first high temperature hydraulic curing system, the SST method was developed to craft a multi-ply, bonded drum shell with single-ply resonance and strength.

All shells are formed in a bonded combination of cross-laminated 2-ply veneer panels; precision milled with overlapping scarf joint seams and cured with our exclusive AcoustiGlue at 1000 PSI of hydraulic pressure.





THE FULL SPECTRUM
OF MASTERWORKS CHOICE
IN SHARP FOCUS

Five distinct drum recipes; each one a combination of sonically proven shell woods, edge profiles, and precision hardware options. Crafted to create a truly unique tonal signature.

MODERN DRY (pgs. 4 - 5)

Quick, top-heavy articulation with controlled low-end.

HERITAGE

(pg. 6) Classic drum feel with enhanced lows and fat top-end slap.

URBAN (pg. 8)

A thin, powerful blend for the precise metropolitan drummer.

STADIUM

(pg. 7) Pearl's thick CZX Maple shell for high-volume power.

STUDIO (pg. 9)

Explosive tonal clarity and articulation for recording.



MODERN DRY

The Modern Dry Recipe blends three sonically unique tone woods for dark, controlled tone and pillowy response. Its subdued sound is excellent for driving, organic stylings.



Listen to Modern Dry played by Will Kennedy of the Yellowjackets at pearldrums.com



MASTERWORKS SONIC-SELECT RECIPE: MODERN DRY KIT POWELL/PERALTA* ONE OF A KIND COLLABORATION KIT FEATURING A2 CUSTOM GLOSS "RIPPER" GRAPHIC WITH BLACK NICKEL-PLATED HARDWARE

* The Powell/Peralta Logo and "Ripper" Graphic are property of Skate One, used with permission.

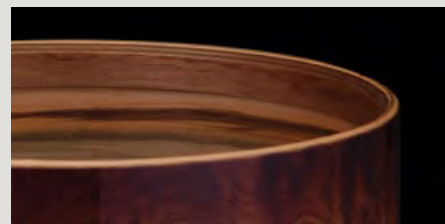

SHELL

2-ply Maple outer/2-ply Gumwood inner with 4 ply Mahogany Re-Rings.

A unique blend of yielding tone woods and rigid exterior for added bottom-end focus.

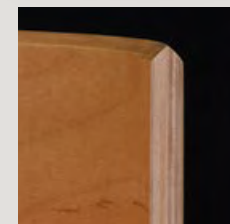

BEARING EDGE

Inner 45° - Its inner shell apex contacts the head inside the shoulder for focused control in low tunings.



HARDWARE

MasterCast Hoops - Gives each drum added weight for increased volume and controlled sustain.



SINGLE STL SWIVEL LUGS

A small pivoting brass tension casing efficiently evens tuning and reduces shell resistance. STL100 / 200

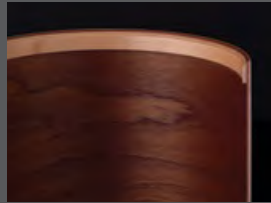

SHELL 4-ply, Maple (2-ply outer) Mahogany (2-ply inner with 4-ply Maple Re-Rings) - A traditional blend of midrange punch and boosted low-end.



A2 CUSTOM FINISH GRAPHICS

Turning the drum shell into a blank canvas, Pearl employs an industry exclusive method to print a choice of high definition graphics directly onto the outer shell ply without affecting the tone or structure of the drum. Consult your authorized Pearl Dealer for more information.



Sitting behind a Masterworks kit is an experience that extends beyond mere sound. It's a luxurious presence, a balance between finesse and power that seems to ignite your very best... and then take it up a notch.

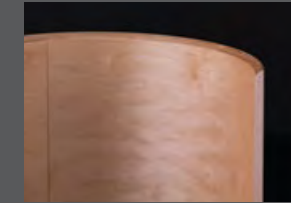

SHELL 10-ply Maple Bass Drums and Floor Toms. 8-ply Maple Toms and Snare Drums. A thick shell for dominating volume and articulate attack.



HERITAGE

The Heritage Recipe's robust organic presence responds like the growl of a classic roadster. Its thin, reinforced shell produces thunderous sub-bass frequencies with exceptional sustain and subtle projection.

STADIUM

The total solution for high volume, commanding presence. This high density shell and hardware combination projects with full bodied midrange and focused low end.

MASTERWORKS SONIC-SELECT RECIPE: HERITAGE KIT IN SATIN OLIVEBURST LACQUER WITH A2 ROSARY BANDS (BY ILLUSTRATOR JESSICA HANCOCK) AND NICKEL-PLATED HARDWARE

MASTERWORKS SONIC-SELECT RECIPE: STADIUM KIT IN FASTBACK YELLOW GLOSS LACQUER WITH BLACK 302 STRIPES AND NICKEL-PLATED HARDWARE



BEARING EDGE

Standard 45° - Precise, low-contact edge for added projection and resonance.



HARDWARE

FatTone Hoops - The light, rigid design of its exclusive hemmed edge increases resonance and tuning stability.



SINGLE STL SWIVEL LUGS

Our lightest and most efficient tuning lug reduces hardware contact and weight on the shell. STL100 / 200

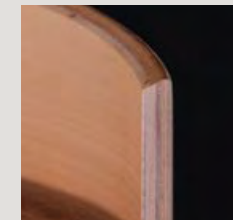

BEARING EDGE

Outer 60° - Increases brightness and power with controlled overtone.



HARDWARE

2.3mm Superhoop II Hoops - Made to withstand heavy play while allowing the shell to breathe.



BRL SWIVEL LUGS

Heavier weight increases attack and assures the ultimate in tuning integrity. BRL100 / 300



From sold out tours to sanctuary halls, this new breed Masterworks formula projects with an urgent, defiant top-end and fills the bass frequencies with thunderous, shaking lows.



SHELL EvenPly-6; 2-Birch/2-Gumwood/2-Birch with 4-ply Maple Reinforcement Rings (8-ply Snare Drums; 2 Birch / 4 Gumwood / 2 Birch). Dense thin shell hybrid for precise punch and quick, even decay.



Listen to the Urban Recipe played by Brian Frasier Moore at pearldrums.com



Listen to the Studio Recipe played by Shannon Forrest of Toto at pearldrums.com

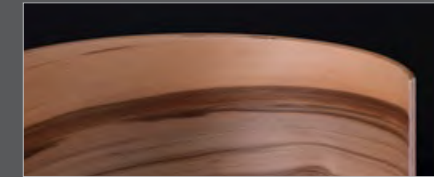

SHELL EvenPly-6, 4-ply Maple outer with 2-ply Gumwood inside – A thin, resonant combination of a hard exterior with milder tonewood for explosive low-range warmth.



A powerful sonic foundation in the recording environment. The Studio Recipe's commanding hardware/shell combination delivers explosive projection in the midrange, for clean tonality and extended low-end punch.



MASTERWORKS SONIC-SELECT RECIPE: URBAN KIT IN GLOSS AMAZON FADE OVER ARTISAN BLACK LIMBA VENEER WITH BLACK NICKEL-PLATED HARDWARE

URBAN



MASTERWORKS SONIC-SELECT RECIPE: STUDIO KIT IN GLOSS REDBURST OVER ARTISAN BURL MAHOGANY VENEER WITH GOLD PLATED HARDWARE

STUDIO

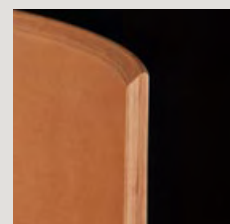

BEARING EDGE

Rounded 45° on Toms (Fully Rounded edge on bass drums, standard 45° on snare drums) Boosts mids and highs in toms, maximizes low-end in the kick.



HARDWARE

2.3mm Superhoop II Hoops – Made for heavy play without limiting tuning range performance.



STL SWIVEL LUGS

A medium-weight lug with pivoting tension casing for increased projection and reduced overtone. STL150 / 300

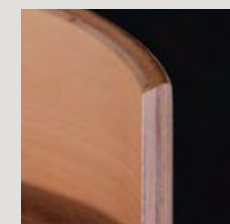

BEARING EDGE

Outer 60° – Gives increased power and bite to a thinner hybrid shell.



HARDWARE

MasterCast Hoops – Escalates weight for tonal body and increases volume in high velocity play

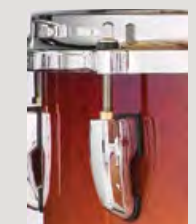

CL BRIDGE LUGS

A classic look with minimal shell contact for precise vibration control. CL100 / 250

Reference



#376 Ultra Blue Fade



#839 Redburst Triband

SONICALLY PROVEN SHELL PERFORMANCE

Utilizing the nearly limitless selection of materials and options from our Masterworks Custom Shop, each Reference tom, snare, and bass drum is individually-optimized with its own shell, hardware, and edge "Recipe" to best capture its intended voice.

Just as single notes combine to make a piano, the total Reference kit's singular, unified voice perfectly captures every nuance of your unique drumming ideal.

SHELL: Maple, Birch & African Mahogany
 SNARE: 20 Ply Matching 13 x 6.5, 14 x 5 or 14 x 6.5*
 FINISH: Super High Gloss Lacquer / Lacquer Sparkles
 HEADS: Remo Clear Emperor Tom, Powerstroke3 Bass
 TOM MOUNTS: Aluminum OptiMount Suspension System
 TOM ARMS: Sold Separately
 HARDWARE: Chrome, Nickel, Black Chrome Plated or Gold Plated
 HOOPS: MasterCast Die-Cast Hoops
 LUGS: BRL Bridge Lugs with Swivel Function

*Sold Separately

REFERENCE RECIPE	SHELL TYPE	BEARING EDGE	SONIC OUTPUT
8" and 10" Toms	Maple(4)/Birch(2) 6-ply (RF 7.5mm / RFP 5.4mm)	Rounded 45°	Cutting projection for high-note pitch
12" Toms	Maple(6) 6-ply (RF 7.5mm / RFP 5.4mm)	Rounded 45°	Transitional mid-note; blend of warmth and cut
13" Toms	Maple(4)/Mahogany(2) 6-ply (RF 7.5mm / RFP 5.4 mm)	Rounded 45°	Top-end slap with added low/bottom end
14" and 15" Toms	Maple(4)/Mahogany(2) 6-ply (RF 7.5mm / RFP 5.4 mm)	Fully Rounded	Bracing low-end with controlled punch
16" Toms	Maple(2)/Mahogany(4) 6-ply (RF 7.5mm / RFP 5.4mm)	Fully Rounded	Full, rounded sustain and gated attack
14" Floor Toms	Maple(4)/Mahogany(4) 8-ply (RF 10mm / RFP 7.2mm)	Fully Rounded	Fat, controlled low-end with smooth roll-off
16" and 18" Floor Toms	Maple(2)/Mahogany(6) 8-ply (RF 10mm / RFP 7.2mm)	Fully Rounded	Fat, controlled low-end with resonant warmth
18" and 20" Bass Drums	Maple(2)/Mahogany(4) 6-ply (RF 7.5mm / RFP 5.4mm)	Fully Rounded	Quick and Punchy with Powerful low-end
22", 24", 26" Bass Drums	Maple(2)/Mahogany(6) 8-ply (RF 10mm / RFP 7.2mm)	Fully Rounded	Booming bass tone with articulate punch

Reference SERIES DRUMS

INDIVIDUALLY ENGINEERED, INCREDIBLE SOUNDING DRUMS.

Handcrafted to escalate your drumming influence, the Reference Recipe unique drum formula retools the playing field with power, tone, and distinction.

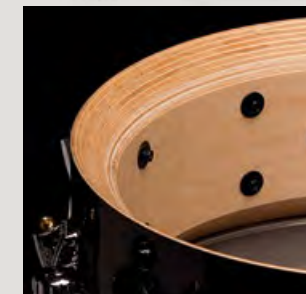

20-PLY REFERENCE SNARE DRUMS

Comprised of six inner Birch plies, 14 outer Maple plies and 45° bearing edges, this staggeringly thick shell projects with volume and articulation without losing tonal body.

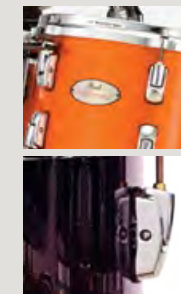

HARDWARE

MASTERCAST HOOPS enhance the overall weight and volume of each shell and stay true under constant play. BRL SWIVEL LUGS feature pivoting internal brass tension casings to assure tuning integrity and reduce shell stress.

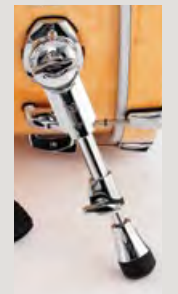

SP300 SPUR

Pearl's SP300 bass drum spur features retractable high grip rubber tip and recessed spike for high impact, slip free play.

THE EVENPLY DIFFERENCE lies in thinner shell layers. Using the same hybrid wood composition as the Reference Recipe with thinner plies gives the Reference Pure shell a lean profile with increased strength. Combining the ultra thin EvenPly shell with more efficient shell hardware reduces overall drum weight by 30% for increased resonance, improved bottom end, and a more nuanced near field playing experience.

- SHELL: Low Mass Evenply Maple, Birch & African Mahogany
- SNARE: 6 Ply Matching 13 x 6.5, 14 x 5, 14 x 6.5 (Sold Separately)
- FINISH: Super High Gloss Lacquer / Lacquer Sparkles
- HEADS: Remo Clear Emperor Tom, Powerstroke3 Bass
- TOM MOUNTS: Aluminum OptiMount Suspension System
- TOM ARMS: Sold Separately
- HARDWARE: Chrome, Nickel, Black Chrome Plated, or Gold Plated
- HOOPS: Low Mass FatTone Hoops
- LUGS: Low Mass STL Swivel Tube Lugs



#844 Satin Rose Gold with Nickel Hardware



#831 Matte Olive Burst with Black Nickel-Plated Hardware RFP924XEDP/BC

HARDWARE



1.6mm FatTone Hoops' exclusive hemmed/welded edge (U.S. Pat. #8367917) gives increased strength to low mass design.

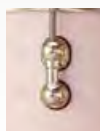

STL Swivel Tube Lugs allow for increased resonance, minimal shell contact, and precisely aligned, no bind tuning.

See full Color Chart on back cover for all Special Order Finishes. ***Nickel and Black Nickel hardware available at premium charge.



SHELL

Boasting the same shell construction that made Reference drums a professional standard, Reference Pure's uninhibited, shell-focused tonality excels in any playing environment.



SNARE DRUMS

A thin EvenPly-6 shell with four outer Maple and two inner Birch plies for cut, projection, and smooth, balanced sound. 45° bearing edges provide superbly articulate sensitivity.

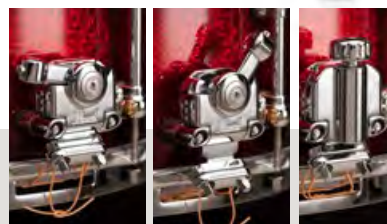

SR1000

SR1000 Glide-Lock Strainer's locking throw off lever and tension knob assures slip-free performance. (U.S. Patent #7220905, #7301087, #7365256)

OPTIMOUNT

Aluminum Tom Mounts suspend the drum evenly across four tension points to allow resistance-free resonance in play.

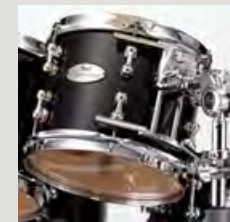

AIR SUSPENSION RUBBER TIP

(U.S. Patent #5881981) isolates the tom from the floor, preventing tonal choke and increasing resonance.



GOLDEN RATIO AIR VENT

(U.S. Patent #7485791) is precision placed in the Fibonacci Spiral on toms to increase low-end response.

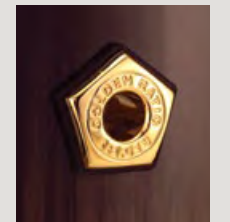



TURN AROUND

GET IT WHEN YOU NEED IT.



The concept is simple but revolutionary: Custom drums crafted from one of Pearl's four professional grade Shell Recipes in your choice of sizes and finishes; hand assembled in Nashville, Tennessee. Most orders are completed within 14 business days from the date we receive your order.

MASTERS MAPLE GUM
(pg. 14-15) Vital, explosive tonality with precise low-end decay.

REFERENCE PURE
(pg. 17) Lively, resonant timbre with increased body and sustain.

REFERENCE
(pg. 16) Maximum projection with powerful, formidable tone.

MASTERS MAPLE RESERVE
(pg. 18) Sonically-balanced attack with smooth midrange.



#415 BRONZE OYSTER



#427 BRIGHT CHAMPAGNE SPARKLE



#763 MATTE BLACK OYSTER

MCC: REFERENCE
Maximum projection with powerful, formidable tone.

MCC: REFERENCE PURE
Lively, resonant timbre with increased body and sustain.



For over 40 years, our exclusive USA Artist Custom shop has collaborated with some of drumming's biggest names to handcraft their personal touring kits. Pearl now invites you to experience the same level of unparalleled service with Music City Custom.



Barry Kerch (Shinedown) and Dustin Steinke (SIXX:A.M.) backstage with their MCC kits.



Casey Cooper (YouTube: COOP3RDRUMM3R) with his MCC RFP kit in #416 Black N' White Oyster.



#447 BURNT ORANGE GLASS



#416 BLACK N' WHITE OYSTER



MCC: MASTERS MAPLE RESERVE

Pearl's classic MRV 4-ply shell with 4-ply re-rings, FatTone hoops, and CL bridge lugs for balanced Maple tone.

#451 Molten Silver Pearl



ARTIST DESIGNED, HAND ASSEMBLED



Explore the option of three premium SST drum shell types; precision drilled to order, assembled, and immediately available in your choice of 36 tour ready finishes. From classic sparkles and vintage pearls to timeless favorites, it's here and ready to define your command of the stage.

Music City Custom provides the true artist experience and a drum set like no other. Quick custom manufacturing, massive size and finish selection, industry leading craftsmanship, and Pearl's exclusive Lifetime Warranty all combine to set a new standard for USA born, high end drum sets.



36 IN-STOCK FINISHES

#403 RED ONYX	#405 NICOTINE WHITE MARINE PEARL (Large)	#407 RED GLASS	#409 DIAMOND GLITTER	#412 BLACK OYSTER GLITTER	#413 TURQUOISE GLASS
#414 ICE BLUE OYSTER	#415 BRONZE OYSTER	#416 BLACK N' WHITE OYSTER	#417 PEWTER ABALONE	#418 BLUE ABALONE	#419 BURNT ORANGE ABALONE
#420 GOLDEN YELLOW ABALONE	#421 BLACK DIAMOND PEARL	#422 MATTE WHITE MARINE PEARL	#423 VINTAGE GOLD SPARKLE	#424 VINTAGE BLUE SPARKLE	#425 CHARCOAL BLACK SPARKLE
#426 MIRROR CHROME	#427 BRIGHT CHAMPAGNE SPARKLE	#446 GREEN GLASS	#447 BURNT ORANGE GLASS	#448 WHITE MARINE PEARL (Large)	#449 CLASSIC SILVER SPARKLE
#451 MOLTEN SILVER PEARL	#452 PEARL WHITE OYSTER	#453 PLATINUM GOLD OYSTER	#495 CLASSIC BLACK OYSTER	#496 PLATINUM SMOKE MARINE	#720 CRANBERRY SATIN SWIRL
#721 BLUE SATIN MOIRE	#722 WHITE SATIN MOIRE	#723 GOLD SATIN MOIRE	#724 SHADOW GREY SATIN MOIRE	#725 SATIN GREY SEA GLASS	#763 MATTE BLACK OYSTER

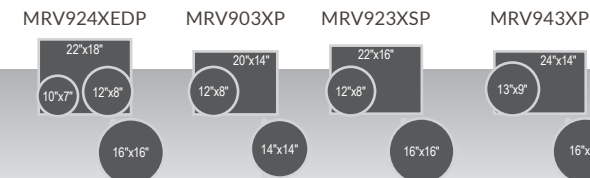

THE MASTERS LEGACY

Derived from Pearl's original Masters shell recipe, Masters Maple Reserve Drums deliver a sophisticated, balanced tonal combination of powerful midrange and sustained resonant shimmer.



#111 MATTE NATURAL #343 OLIVE BURST #353 MATTE WHITE
 #355 ANTIQUE WALNUT #359 TWILIGHT BURST #839 REDBURST TRIBAND

Masters Maple Reserve is available in all 36 Music City Custom special order finishes - see Page 19.

Also available in 28 Special Order Lacquer finishes - see Back Cover.

- SHELL: 4-ply (5mm) 100% Maple w/ 4-ply Maple Re-Rings
- SNARE: Matching 14x5.5 or 14x6.5 (Sold Separately)
- FINISH: Super High Gloss and Matte Lacquer
- HEADS: Remo Clear Ambassador Tom, Ported Powerstroke3 Bass
- TOM MOUNTS: Aluminum OptiMount Suspension System
- DRUM HARDWARE: Chrome***
- HOOPS: Low Mass FatTone Hoops
- LUGS: CL Bridge Lugs
- BD MUFFLER: BDMF (Full Size)



#839 Redburst Triband Lacquer with Gold Hardware*** and added component Floor Tom and Snare MRV943XPG

***Gold hardware available at premium charge.

SHELL

4-ply Maple shell with 4-ply Maple Reinforcement Rings. A classic shell fusion delivering rich, sustained lows and controlled sonic punch.

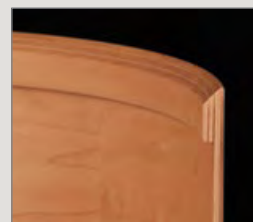

HARDWARE

FatTone Hoops - Rigid 1.6mm hemmed/welded edge extends sustain with punchy projection.

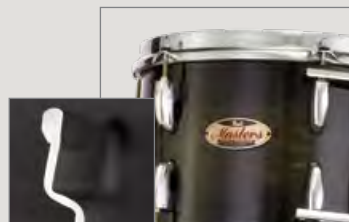

BEARING EDGE

Standard 45°

CL BRIDGE LUGS

A classic lug with a minimal contact arc for precise vibration control.

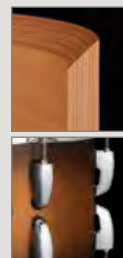

ALUMINUM OPTIMOUNT SUSPENSION SYSTEM

Light and efficient four-point contact design delivers secure tom mounting without penetrating the shell.



#359 Twilight Burst MRV924XEDP/C





#186 Hand Rubbed Natural Maple
MMG924XSP/C

Delivering arguably the greatest drum tones ever recorded, Pearl's fresh take on the legendary Maple/Gum shell recipe reaches new levels in dynamic sonic warmth and explosive low-end response.

Now, Pearl expands Masters Maple/Gum with updated finish and component options; making our first production Masterworks kit a true prize for the owner.

SHELL: EvenPly Six (6-ply, 5.4mm)
North American Maple/Gum
FINISH: Hand-Rubbed Natural Wax or Premium USA Wrap
HEADS: Remo Coated Ambassador, Powerstroke3 Bass
TOM MOUNTS: OptiMount Aluminum Suspension System
DRUM HARDWARE: Chrome
HOOPS: Mastercast Die-Cast
LUGS: CL Bridge Lugs



#453 Platinum Gold Oyster with Added 14" x 14" Floor Tom (MMG1414F/C)
MMG924XSP/C



SHELL

EvenPly-6, 4-ply Maple outer with 2-ply Gumwood inside -The natural warmth of Maple is enhanced by Gumwood's dense, controlling character.



BEARING EDGE

Outer 60° - Gives increased power and bite to a thinner hybrid shell.



HARDWARE

MasterCast Hoops: Escalates weight for tonal body and increases volume in high velocity play.



CL BRIDGE LUGS

A classic look with minimal shell contact for precise vibration control.

CL100 / 250

FINISHES

#186 HAND RUBBED NATURAL MAPLE



Masters Maple Gum is available in all 36 Music City Custom special order finishes - see Page 19.



36 SPECIAL ORDER FINISHES

CONFIGURATIONS

MMG924XSP/C MMG904XP/C

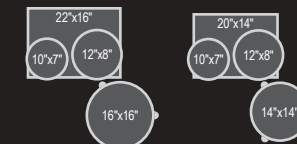

Added components in #186 can be special ordered.

MASTERS MAPLE COMPLETE

AN ALL MAPLE DRUM SHELL
FIT FOR THE MASTERS LEGACY



#823 Cain and Abel
A2 Custom graphic derived from "Cain&Abel: The Offering" by Illustrator Jessica Hancock, used with permission

#837 Chrome Contrail
MCT903XP/C

UNPARALLELED SOUND.
ATTAINABLE PRICE.

Fully loaded with all the elements that made Pearl's Masters Series a must for the touring drummer, Masters Maple Complete offers a tonally superior percussive statement for the road ready pro.

- SHELL: EvenPly Six (6-ply, 5.4mm) 100% Maple
- SNARE: Matching 14x5.5 or 14x6.5 (Sold Separately)
- FINISH: Super High Gloss Lacquer or Premium USA Wraps
- HEADS: Remo UT Pinstripe Tom, Ported UT Powerstroke3 Bass
- TOM MOUNTS: OptiMount Suspension System
- DRUM HARDWARE: Chrome
- HOOPS: Superhoop II 2.3mm Triple Flanged
- LUGS: CL Bridge Lugs

Five premium finishes are available in four preconfigured shell packs, as well as a host of component and add-on drums.

MCT924XEDP/C MCT903XP/C

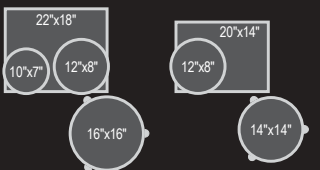

MCT923XSP/C MCT943XP/C

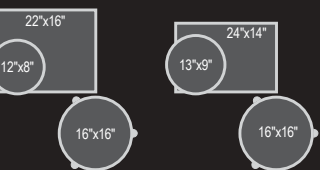

SHELL

EvenPly-Six (5.4mm) North American Maple - Fuses reduced thickness, cross laminated ply panels for expanded tonal purity and increased resonance.

BEARING EDGE

Standard 45° - Pearl's original precision edge adds sustain through reduced shell-to-head contact.

HARDWARE

2.3mm Superhoop II Hoops - Made to maintain tuning integrity in heavy play while delivering maximum shell resonance.

CL BRIDGE LUGS

A classic look with minimal shell contact at separate points for precise vibration control.

FINISHES

- #448 WHITE MARINE PEARL
- #823 CAIN AND ABEL
- #836 RED BURST STRIPE
- #837 CHROME CONTRAIL
- #841 PIANO BLACK WITH SILVER STRIPE

A TRUE PEARL ORIGINAL, WITH A FRESH, GROOVE INSPIRING VIBE.

Taking a tip from the Masterworks spectrum, Session Studio Select's unparalleled combination of Masters-grade Birch and African Mahogany deliver a refined standout for recording and gigging.



#414 Ice Blue Oyster
STS925XSP/C



#314 Gloss Barnwood Brown
STS925XSP/C

HIGH GLOSS LACQUER



#112 NATURAL BIRCH #314 GLOSS BARNWOOD BROWN #315 ANTIQUE CRIMSON BURST

PREMIUM DELMAR WRAP



#405 NICOTINE WHITE MARINE PEARL #414 ICE BLUE OYSTER #766 BLACK MIRROR CHROME



#112 Natural Birch
STS944XP/C

SESSION STUDIO SELECT



SHELL

EvenPly-Six Birch/African Mahogany. A unique sonic dichotomy of piercing projection, smooth low-end and pre-EQ'd punch.



BEARING EDGE

Outer 60-Degree. Increases volume and punch without harsh overtones.



HARDWARE

SuperHoop II, 2.3mm Triple-Flanged hoops for rigid tuning stability without robbing the shell of sustain.

PROFESSIONAL SOUND. CLASSIC VALUE.

The Session tradition of value for the drummer lives on with three specially priced shell packs, each including a FREE added floor tom.

STS925XSP/C

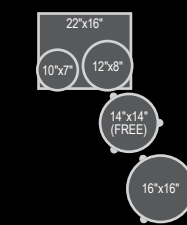

STS944XP/C

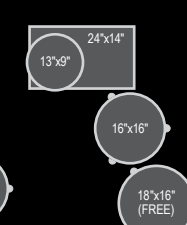

STS905XP/C



SHELL: EvenPly Six (6-ply, 5.4mm) Birch/African Mahogany
SNARE: 14x5.5, 14x6.5, or 14x8 Matching Wood*
FINISH: Premium Wrapped or High Gloss Lacquer
HEADS: Remo Pinstripe Clear Tom, Powerstroke3 Bass, UT Coated Snare
TOM MOUNTS: OptiMount Suspension System
TOM ARMS: Sold Separately
DRUM HARDWARE: Chrome
HOOPS: SuperHoop II 2.3mm Triple Flanged
LUGS: RL Lugs

*Sold Separately



#730 Ultra Clear Crystal Beat Single-Headed Component toms from 6" to 16" now available in #730 Ultra Clear.

#731 Ruby Red
CRB525FP/C

#732 Tangerine Glass
CRB543P/C



Originating in 1973, Pearl's Crystal Beat Acrylic drums feature a 7mm molded/seamless Acrylic shell for a vivid combination of cutting tonal power and stunning visual appeal.



SEAMLESS ACRYLIC SHELL Loud and immediate, delivers pummeling straight tone and yielding feel. Dual 45° bearing edge with a rounded apex, adding control and increased articulation to acrylic's sonic signature.



TOMS include the OptiMount suspension system for increased sustain and 1.6mm triple-flanged hoops for attack and punchy tonal body.

SHELL: 7mm Seamless Molded Acrylic
SNARE: Matching Free Floater (Sold Separately)
FINISH: Transparent
HEADS: 2-Ply on Tom Batters, Single-Ply Resonant
TOM MOUNTS: OptiMount Suspension System
TOM ARMS: Sold Separately
DRUM HARDWARE: Chrome
HOOPS: 1.6mm Triple-Flanged
LUGS: CB Mid-Lugs on Toms, CB Fat-Lugs on Bass

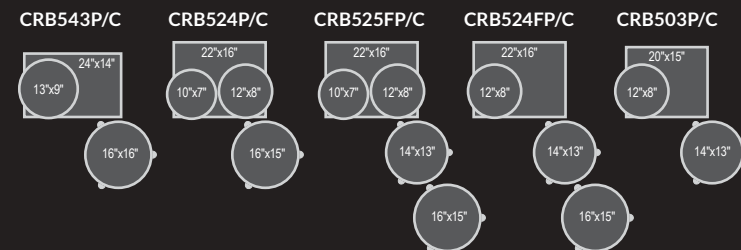

Crystal Beat is available in a choice of four engaging colors, a host of sizes and set-ups, and even single-headed and Rocket tom options for a clearly striking drum statement.





#225 Classic Satin Amburst
(Snare Sold Separately)
DMP943XP/C



#229 White Satin Pearl
(Snare Sold Separately)
DMP943XP/C



#216 Kobalt Blue Fade
DMP927SP/C

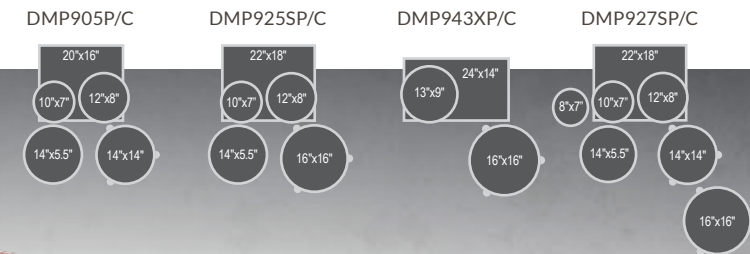

THE DECADE DIFFERENCE



SHELL

6-ply/5.4mm Maple - Thin (but powerfully strong) Pearl's SST shell reacts quickly to the stroke with beautifully resonant highs and thundering lows.



OPTI-LOC MOUNTING SYSTEM

This three-point isolation mount suspends the drum at two tuning points and one of the drum's air vents for solid, stable play.



HARDWARE

Uni-Lock gearless Tom Arms. R40 Air Suspension Floor Tom feet. NDL Mini Lugs: For reliable, rock solid durability and sound.

DECADE MAPLE

Built to push the boundaries of performance and price, Decade Maple Series drums elevate the playing field for the advancing drummer with pro features and unbeatable value.



SHELL: Even Ply 6 (5.4mm) 100% Maple
 SNARE: 14 x 5.5 Matching
 FINISH: High-Gloss / Matte Lacquer
 HEADS: Remo UT Clear Ambassador Tom, Ported UT Powerstroke3 Bass
 TOM MOUNTS: Opti-Loc Mounting System
 DRUM HARDWARE: Chrome
 HOOPS: 1.6mm Steel Triple Flanged
 LUGS: NDL Lugs
 BD MUFFLER: BDMM (Mini)

The Export Series 30 year pedigree of unbeatable quality and value shines on with Reference-inspired shell woods and high impact hardware, giving the rising player a truly high end playing platform.

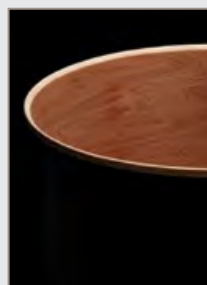

SHELL

6-ply/7.5mm Poplar/Asian Mahogany. A Pearl SST (Superior Shell Technology) blend for high volume resonance and sustained low-end punch.



EXX725/C
EXL725/C

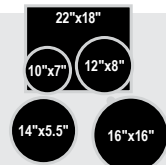

EXX725S/C
EXL725S/C

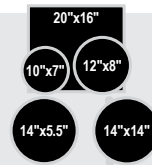

EXX705N/C
EXL705N/C

Export Series drums are available in three preconfigured packages with our robust 830 Series hardware; and feature a choice of gorgeous lacquer (EXL) or durable wrapped (EXX) finishes.

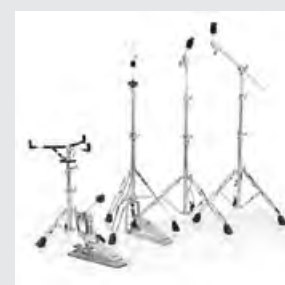

830 SERIES HARDWARE

Sophisticated, sturdy, and efficient, Export's 830 Series Boom (BC830), Cymbal (C830), and Snare (S830) stands all feature gearless Uni-Lock Tilters for pinpoint positioning, and robust double-braced tripods for secure stability in play. The H830 Hi-Hat stand also features swivel legs that accommodate double pedals.



Drum Pedal
P930

P930 PEDAL

Featuring the longboard styling and feel of Pearl's Demon Drive pedal, the P930 offers two chain drive cam options for power, speed, and control.

OPTI-LOC MOUNTING SYSTEM

Pearl's three way tom mount delivers wobble free stability by suspending the drum at two tuning points and one of the drum's two air vents.



#222 Gloss Tobacco Burst
EXL725/C

#760 Burgundy
With Double Bass Add-On Pack (EXX22P/C)
EXX725S/C



#220 SATIN BROWN #222 GLOSS TOBACCO BURST #246 NATURAL CHERRY #248 BLACK SMOKE #249 HONEY AMBER

SHELL: 6 Ply 7.5mm Birch/Poplar & Asian Mahogany Blend
SNARE: 14 x 5.5 Matching Wood Snare
FINISH: Choice of 4 High Gloss Lacquer Finishes and 1 Satin Finish
HEADS: Remo Clear Tom Head, Powerstroke Bass Head
TOM MOUNTS: Opti-Loc Mounting System
TOM ARMS: TH70I
DRUM HARDWARE: Chrome
HARDWARE: P930, BC830, C830, H830, S830
BD MUFFLER: BDMM (Mini)



#21 SMOKEY CHROME #31 JET BLACK #33 PURE WHITE #49 MIRROR CHROME #708 GRINDSTONE SPARKLE #717 HIGH VOLTAGE BLUE #760 BURGUNDY

SHELL: 6 Ply 7.5mm Poplar & Asian Mahogany Blend
SNARE: 14 x 5.5 Matching Wood Snare
FINISH: Choice of 7 Covered Finishes
HEADS: Remo Clear Tom Head, Powerstroke Bass Head
TOM MOUNTS: Opti-Loc Mounting System
TOM ARMS: TH70I
DRUM HARDWARE: Chrome
HARDWARE: P930, BC830, C830, H830, S830
BD MUFFLER: BDMM (Mini)

MIDTOWN

BIG GIG, SMALL RIG, HUGE SOUND



#701 Black Gold Sparkle
MDT764P/C

Lift used on Midtown raises the drum to the optimal position for your pedal.



SETTING THE PULSE FOR THE METROPOLITAN GROOVE

With full size sound and play in a smaller footprint, Pearl's ultra portable Midtown Kit is a perfect sounding board for the gigging drummer on the move. Ideal for tight spaces and tight budgets.

INSTANTLY PORTABLE

The Midtown Kit's compact size quickly breaks down into two optional gig bags (PMTBG) for quick transport.



6 Ply 7.5 mm Poplar

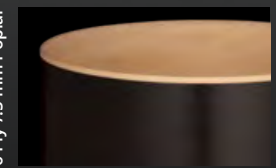

Quick and biting attack with lively overtones.

SHELL: 6 Ply 7.5 mm Poplar
SNARE: 13 x 5.5 Matching Wood Snare
FINISH: Choice of 2 Covered Finishes
HEADS: Remo Clear Toms, Powerstroke Bass, Clear Batter Coated Front
TOM ARMS: TH70I
HARDWARE: Chrome

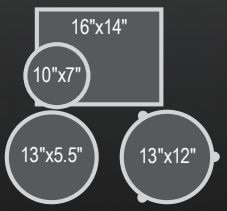

COMPACT TRAVELER

Perfect for school, street, practice, and stage, the Compact Traveler has a slim 18" bass drum and 10" snare mount off an included 3/8" post. Now expandable with added frame-based toms/drums.



Compact Traveler shown with PCKTK1014 add on pack, HW/Cymbals sold separately PCKTK1810



Optional Compact Traveler Bag PSCPCTK



Optional Compact Traveler Add on Bag PSCPCTKADD

SHELL: 9 Ply 7mm Asian White Poplar
SNARE: Matching Wood Snare
FINISH: Choice of 5 Covered Finishes
HEADS: Clear Tom Heads, Coated Snare Head, Self-Muffled Bass Head
TOM ARMS: Individually Locking 7/8" Tube Joint Holders
HARDWARE: Dual-Chain Drive Bass Drum Pedal, Double-Braced Cymbal*, Snare, and Hi-Hat Stands, Double-Braced Throne
CYMBALS: 16" Brass Cymbal, 14" Brass/Hybrid Hi-Hat Cymbals
ACCESSORIES: Pro Drum Stick Bag, Two pair of Maple 5A Sticks
*Docking Cymbal Boom Arm Included with RS584C/C



THE RHYTHM IS IN YOU

Drumming knows no age limit. Regardless of when your rhythmic journey starts, Pearl's Roadshow Series has a drum set package scaled for players of all ages that includes everything you need to get on the road to drumming greatness.



BASS DRUM PEDAL



THRONE INCLUDED

STANDARD CONFIGURATIONS

Complete Sets with Hardware, Cymbals, and Throne.



#91 Red Wine RS525SC/C

#31 Jet Black RS525WFC/C

#707 Bronze Metallic RS505C/C

#706 Charcoal Metallic RS584C/C

IT'S YOUR TIME TO PLAY, START THE RIGHT WAY!

ROADSHOW



#703 Aqua Blue Glitter RS525SC/C

THE HEART OF THE ROADSHOW SOUND. Roadshow is crafted to be everything you'd expect from a Pearl Drum set, featuring a 9 ply Poplar shell for optimum tonal power.



#31 JET BLACK #91 RED WINE #703 AQUA BLUE GLITTER #706 CHARCOAL METALLIC #707 BRONZE METALLIC



NATE MORTON THE VOICE

For additional info, testimonials, free assembly and instructional videos, and access to the largest drummer's community on the web, go to:

WWW.MYFIRSTDRUMSET.COM

ROADSHOW JR.

Following in the footsteps of Pearl's Roadshow series for beginning drummers, this is not merely a toy made to look like a drum set. The Roadshow Jr. is an all-in-one five piece kit featuring hardware, cymbals, and sturdy White Poplar shell construction for an exceptional, tuneable, powerful playing experience.

Complete with Hardware, Cymbals, and Throne for Drummers under 10.

RSJ465/C

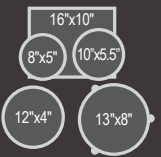

#31 Jet Black RSJ465/C

#708 Grindstone Sparkle RSJ465/C



e/HYBRID CONFIGURATION
10", 12" and 14" toms, a 14" snare, and 18" acoustic bass drum. PUREtouch Cymbals, ICON e-Rack, MDL1 Module. **EM53HB**



e/TRADITIONAL CONFIGURATION
10", 12" and 14" toms, a 14" snare, and PUREtouch Kick Pad. PUREtouch Cymbals, ICON e-Rack, MDL1 Module. **EM53T**

The foundation of the e/MERGE electronic drum set is a custom designed, chrome plated ICON e-Rack system.

e/MERGE

NOT JUST A NEW STANDARD.
A NEW SOUND. A NEW FEEL. AND, A COMPLETELY NEW E-DRUMMING EXPERIENCE.

e/MERGE is about change, and change in the e-drum market has been way overdue. When we looked closely at every aspect of the current e-drumming experience with KORG, together we knew we could make a dramatic difference. And that difference begins with the all new e/MERGE module. Simple yet elegant in design, the e/MERGE MDL1 module features a full library of high definition, natural, organic and minimally processed acoustic Pearl drums. We then added the very best electronic, world, orchestral and specialty percussion sounds from KORG's vast library of pristine quality samples. But, the module is only part of the change.

There are three key elements that separate e/MERGE from anything that has come before. The all new MDL1 e/MERGE Module, KORG's amazing WAVE TRIGGER TECHNOLOGY and Pearl's acoustic-like PUREtouch electronic pads and cymbals combine to create an exceptional e-drumming experience.

e/MERGE MDL1 MODULE Simple, straight forward yet extremely powerful, the MDL1 module offers, a pair of powerful multicore processors, a full library of acoustic Pearl drums recorded in one of the world's most renowned studios, pristine samples from KORG's library and the variety of routing options every e-drummer needs.



WAVE TRIGGER TECHNOLOGY This ultra-fast and highly sensitive technology partially based upon KORG's groundbreaking Wave Drum allows even your stick choice to make a discernible difference in the sound of your drum.



MODULE SPECIFICATIONS

SOUND GENERATOR	2 CPU (4 core + 2 core)
POLYPHONY	128 Voices
VOICE	700 HD Sound Library
DRUM KIT	35 HD Kits
EFFECTS	36
SONG RECORDING TYPE	44.1kHz, 16 Bit WAV
SONG RECORDING TIME	Approximately 12 Hours
CLICK TEMPO	BPM 30 - 300
BEAT	1/2 - 24/2, 1/4 - 24/4, 1/8 - 24/8, 1 - 24/8T, 1/16 - 24/16 (T=Triplet)
CLICK VOICES	10
CONTROLLERS	Knobs and Ambient Slider Control



PUREtouch PADS & CYMBALS
Perfectly sized pads designed to replicate the ultimate acoustic-like response. PUREtouch features layer upon layer of specially designed materials each selected for a specific quality that together create an e-quality never before possible.

(PUREtouch Pads U.S. Patent #10475424)
(PUREtouch Hi-Hats U.S. Patents #10475430, 10482855)



DISPLAY CONNECTORS

3.25" x 1" Graphic LCD
Master Out L/Mono & R
Direct Out (8)
Headphones Out
Aux In TRS Mini
Main Trigger inputs (DB-25 Connector)
Accessory Inputs (3)
USB to PC Port (Transport USB Audio & MIDI Data)
USB-A (for WAV files and Settings Data)
MIDI Output
POWER SUPPLY
100-120V, 50-60Hz, Switching Power Supply
DIMENSIONS, WEIGHT
2.2lbs, 9"W x 7.5"D x 2"H



MIMP24B



THE MOST AMAZING DRUM MODULE THE WORLD HAS EVER KNOWN. SERIOUSLY, IT'S THAT GOOD.

Superior sound, accurate triggering and connectivity are the most important features of a drum module. Pearl Drums and Steven Slate have joined forces to create "Mimic Pro" - the world's most advanced percussion sound source for studio and live performance applications.

At the heart of this ground breaking unit is the new Steven Slate 5 drum library that features multi-channel drum samples recorded in world class studios. Each instrument supports adjustment of Attack, Sustain, Release, Tune, Pan and volume. Instead of substituting digital effects to create ambience, these instruments use the actual ambient recordings with separate adjustment of close, overhead and room mics.

Mimic Pro is the first drum module to implement a 7" IPS touch screen and the first to offer 2 mixers for independent headphone and front house outputs. Now that the drummer is responsible for triggering loops and other sounds for a performance, Mimic Pro can import audio files to trigger from your pads.

Storage is no longer a problem with Mimic's 120GB Solid State Drive and lightning fast loading time. Speaking of connectivity, Mimic Pro is compatible with Pearl TruTrac pads and a host of pads from other manufacturers. Top that off with sixteen audio outs, 16 Trigger inputs, independent SD card Slot, USB and Midi In & Out, Stereo Aux input and you would be hard pressed to find a better option for today's musician.



STATE OF THE ART FEATURES:

- 7" IPS Touch Screen with Programmable Data Wheel
- 120 gig Solid State drive
- 16 Dual Zone Inputs
- 16 Programmable Audio Outputs
- Midi In and Out
- High Quality Digital to Analog Converters
- Two completely separate mixers for headphone and Main outs. (Drummer gets a personal mix with and without effects independent of Main outputs)
- Import Wave, Aiff or MP3 sound files
- Compatible with most pads on the market
- Steven Slate Drums 5 Library
- 24 bit multi channel sample library with separate adjustment of Close, Overhead and Room mics.
- Onboard effects include EQ, Compression, Reverb with Room Sizes
- Individual Cymbal Volume Adjustments for Bell, Bow, Edge, Chik and Splash
- All AUX and Cymbal inputs have choke function.
- Supports triple and dual zone hi hat. cymbals and dual zone hi hat.
- SD card slot and USB.
- Additional Instruments and Libraries will be available
- Stereo Aux In and Onboard Metronome
- Internal Recording for Loops and/or Performances

malletSTATION

THE WORLD'S FIRST 3.0 OCTAVE ADJUSTABLE RANGE ELECTRONIC MALLET CONTROLLER

EM1

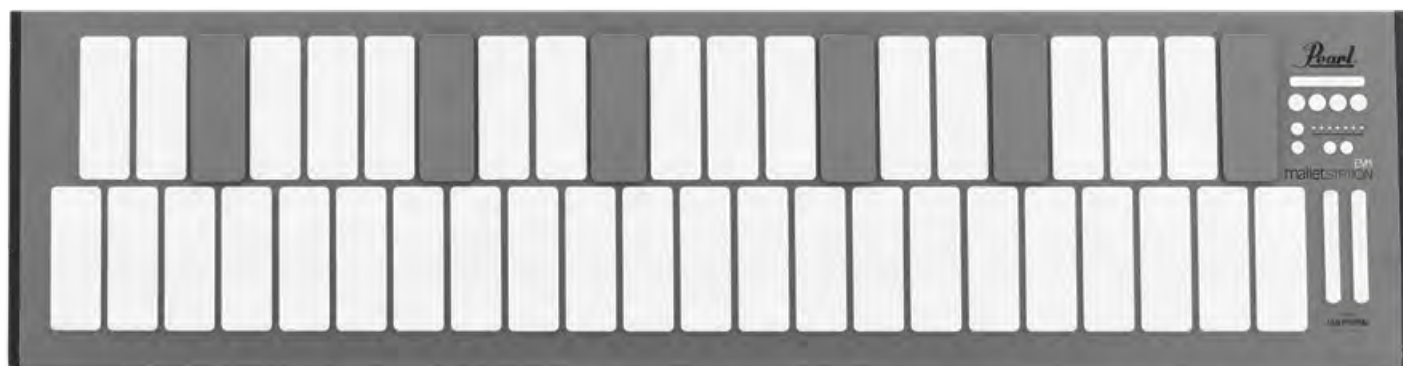

Shown Mounted on Vibraphone with Field Frame

Sleek, modern design with an ultra thin 1.6" profile

PRACTICE, PERFORM, COMPOSE ANYWHERE.

- USB Powered MIDI Mallet Keyboard Controller
- Universal Compatibility through phone/tablet/laptop
- Tech-Forward Design featuring KMI Smart Fabric Sensors
- Low Note, Adjustable, User defined 3.0 Octave Range
- Customizable mallet dampening and aftertouch modes for realistic performance techniques
- Natural feeling soft silicone keys, all-weather playing surface
- Assignable buttons and faders for customized control and functions
- Three assignable pedal inputs for expression and sustain
- Hybrid Aluminum and Steel Chassis design for durability and stability
- Optional MIDI Expander to use external MIDI Hardware (sold separately)
- Flexible mounting on desktop, X-stand, or module mounts (sold separately)
- Mounting plates, stands, cases, covers, and other peripherals (available separately)

- 43, 1.75" x 5" soft silicone keys • 3 faders and 4 buttons, MIDI assignable
- 3 MIDI assignable ¼" pedal inputs
- Bottom Note Range Shift up/down buttons • Octave up/down buttons
- 1.6" H x 12.6" W x 49" L • 22.5 lbs

malletSTATION™



1.75" x 5" Soft Silicone Keys powered by KMI Smart Fabric Sensor Technology

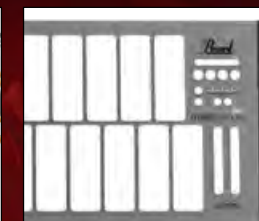

Software Assignable Control Panel with 3 Faders, 4 Buttons, plus Low Note and Octave Shift

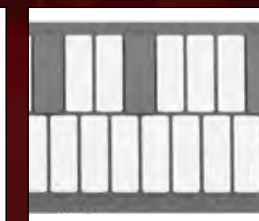

Moveable Accidental "Gap Caps" for visual cues when low note range is adjusted



Jack panel with USB MIDI, MIDI expander port, and 3 MIDI assignable ¼" pedal inputs

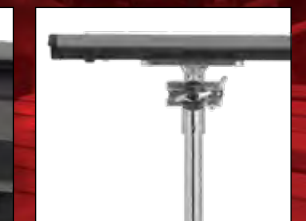

Optional Dual Module Mounts allow malletSTATION to easily mount on racks, stands, and field frames

Pearl once again redefines the electronic percussion experience by introducing the revolutionary EM1 malletSTATION adjustable range electronic mallet controller.

The EM1 malletSTATION is a 3.0 octave adjustable range electronic mallet controller designed for all levels of player, from the beginning student through the gigging professional. The adjustable range function allows you to set the fundamental diatonic note of the instrument to what you need—low D xylophone? No problem! Powered exclusively by USB Bus Power, the malletSTATION is designed to be used with

Mac, PC, iPad, iPhone, and Android devices, making it the first truly portable mallet percussion controller on the market.

Designed in collaboration with Keith McMillen Instruments, malletSTATION's tech-forward design features KMI's Smart Fabric Sensor technology allowing the silicone bar material to have an extremely sensitive, natural response, including mallet dampening and aftertouch control, and all can be easily tailored to your individual playing style. The EM1 features a master control section, with 3 programmable faders, 4 programmable buttons, and the fixed function low note

and octave shift buttons. In addition, three assignable pedal inputs allow for flexibility in performance such as sustain, expression, or any MIDI parameter of your choice. These controls are fully programmable through a software editor so changing your configuration is as easy as clicking a mouse.

This is the controller that will grow with you throughout your playing career—from music apps on your phone or tablet, to professional digital audio workstations and sound libraries—your sounds and even the instruments you play are only limited by the software you run.

DISCOVER THE ALL NEW, MADE IN USA SNARE DRUM YOU'VE BEEN WAITING FOR.

A singular tonal expression that elevates your approach to playing - and feeling - the drums.

Pearl's Music City Custom Solid Shell Snare Drums are uniquely refined, American made percussion instruments crafted with time honored precision. Using an old world technique derived from the shipbuilding trade, each solid shell is meticulously hand-formed from a steam treated plank of premium North American Lumber.

Each Music City Custom Solid Shell Snare is then drilled with CNC precision before being hand finished and assembled by our Custom Shop team in Nashville, TN.

The natural beauty of each shell is further refined with a hand-rubbed oil finish available in a choice of standard Nashville Natural or with one of our exceptional, exotic inlay options. Pearl's Music City Custom Solid Shell Snare Drums are truly instruments elevated above all others.



SOLID MAPLE
The standard for premium, tonally centered midrange punch and restrained overtone.



SOLID CHERRY
Slightly brighter in tone than Maple with cutting projection. Best suited for a higher velocity stroke.



SOLID WALNUT
A fat growl with a naturally darker tone, the sound of Walnut is a perfect complement to its luxurious grain.



SOLID ASH
Brighter, louder, and with the crack of a homerun hit, the tonal quality of Ash is punchy with extended sustain.



Our handcrafted Solid Shell Snare Drums all feature Solid Maple Reinforcement Rings bonded to both top and bottom of the shell interior.



Shell: 8mm w/ 6mm solid Maple Re-Rings
Edge: Standard 45°
Hoops: SuperHoop II Triple-Flanged
Lugs: STL100
Tension Rods: Stainless Steel
Strainer: SR017
Snares: SN14201

FINISH AND INLAY OPTIONS

Craft an instrument that truly demands your attention. Each Solid Shell Wood Option is available in your choice of hand rubbed Nashville Natural (without inlay) or configured with one of these exotic inlay options:

#1003
DUOBAND EBONY MARINE INLAY

(Shown on 14" x 6.5" Ash)
A White Nicotine Marine Pearl band surrounded by dual inlay strips of Macassar Ebony.
• Available only on 6.5" models



#1002
KINGWOOD ROYAL INLAY

(Shown on 14" x 6.5" Maple)
Centered Nicotine White Marine Pearl band surrounded by dual Kingwood inlay strips.
• Available only on 6.5" models



#1004
BOXWOOD-ROSE TRIBAND INLAY

(Shown on 14" x 6.5" Cherry)
Three thin bands of Artisan Rosewood and Boxwood creates a stunning inlay.
• Available only on 6.5" models



#1001
KINGWOOD CENTER INLAY

(Shown on 14" x 5" Maple)
A dark, dense inlay from the exotic Brazilian Rosewood family with a rich vertical grain.
• Available on all 5" & 6.5" models



#1006
BOXWOOD-ROSE SINGLE INLAY

(Shown on 14" x 5" Walnut)
A single strip of combined Artisan Rosewood and Boxwood for an elegant inlay.
• Available only on 5" models



#1005
NICOTINE WHITE MARINE INLAY

(Shown on 14" x 5" Maple)
Embeds a single 6mm band of White Nicotine Marine Pearl in the shell center.
• Available only on 5" models



#1007
EBONY SINGLE INLAY

(Shown on 14" x 5" Maple)
A solitary center inlay of imported Macassar Ebony.
• Available only on 5" models



REFERENCE SNARES

THE ULTIMATE STABLE OF SNARES



All Reference snare drums feature Pearl's SR1000 Glide-Lock Strainer, which includes a locking throw off lever and tension knob that won't loosen no matter how hard you play. Low-friction technology permits smooth gliding action for ultra quiet, super precise motion. U.S. Patent #7220905, #7301087, #7365256

RF1450S/C | 14" x 5"

Shell: 20 ply (25mm): Maple 14 + Birch 6
Hoops: MasterCast (DC1410/1410S)
Lugs: BRL55
Tension Rods: SST5047 Stainless Steel
Strainer: SR1000 Glide-Lock Strainer
Snares: SN1420D Ultra Sound "D" type

RFP1450S/C | 14" x 5"

Shell: 6 ply (5.4 mm): Maple 4 + Birch 2
Hoops: FatTone Hoops (FH1410/1410S)
Lugs: STL55L
Tension Rods: SST5042 Stainless Steel
Strainer: SR1000 Glide-Lock Strainer
Snares: SN1420D Ultra-Sound "D" type

RF1465S/B | 14" x 6.5"

Shell: 20 ply (25mm): Maple 14 + Birch 6
Hoops: MasterCast (DC1410/1410S)
Lugs: BRL65
Tension Rods: SST5047 Stainless Steel
Strainer: SR1000 Glide-Lock Strainer
Snares: SN1420D Ultra Sound "D" type

RFP1465S/C | 14" x 6.5"

Shell: 6 ply (5.4 mm): Maple 4 + Birch 2
Hoops: FatTone (FH1410/1410S)
Lugs: STL65
Tension Rods: SST5047 Stainless Steel
Strainer: SR1000 Glide-Lock Strainer
Snares: SN1420D Ultra-Sound "D" type



RF1365S/C



RFP1365S/C

RF1365S/C | 13" x 6.5"

Shell: 20 ply (25mm): Maple 14 + Birch 6
Hoops: MasterCast (DC1308/1308S)
Lugs: BRL65
Tension Rods: SST5047 Stainless Steel
Strainer: SR1000 Glide-Lock Strainer
Snares: SN1320D Ultra Sound "D" type

RFP1365S/C | 13" x 6.5"

Shell: 6 ply (5.4 mm): Maple 4 + Birch 2
Hoops: FatTone Hoops (FH1308/1308S)
Lugs: STL65
Tension Rods: SST5047 Stainless Steel
Strainer: SR1000 Glide-Lock Strainer
Snares: SN1320D Ultra-Sound "D" type

RFB1450 | 14" x 5"

Shell: 3mm Brass
Hoops: MasterCast (DC1410/1410S)
Lugs: BRL55
Tension Rods: SST5047 Stainless Steel
Strainer: SR1000 Glide-Lock Strainer
Snares: SN1420D Ultra Sound "D" type

RFB1465 | 14" x 6.5"

Shell: 3mm Brass
Hoops: MasterCast (DC1410/1410S)
Lugs: BRL65
Tension Rods: SST5042 Stainless Steel
Strainer: SR1000 Glide-Lock Strainer
Snares: SN1420D Ultra-Sound "D" type

RFS1450 | 14" x 5"

Shell: 2.5mm Cast Steel / 2.5mm R-Ring
Hoops: MasterCast (DC1410/1410S)
Lugs: BRL55
Tension Rods: SST5047 Stainless Steel
Strainer: SR1000 Glide-Lock Strainer
Snares: SN1420D Ultra-Sound "D" type

RFS1465 | 14" x 6.5"

Shell: 2.5mm Cast Steel / 2.5mm R-Ring
Hoops: MasterCast (DC1410/1410S)
Lugs: BRL65
Tension Rods: SST5047 Stainless Steel
Strainer: SR1000 Glide-Lock Strainer
Snares: SN1420D Ultra-Sound "D" type

SERIES COMPONENT

MASTERS, SESSION, DECADE - CLASSIC PEARL SOUND

MRV1455S/C | 14" x 5.5"

Shell: 4 Ply Maple with 4 ply Maple R-Rings
Hoops: FatTone (FH1410/1410S)
Lugs: STL55
Tension Rods: SST5055 Stainless Steel
Strainer: SR017
Snares: S022N



MRV1455S/C



MRV1465S/C

MRV1465S/C | 14" x 6.5"

Shell: 4 Ply Maple with 4 ply Maple R-Rings
Hoops: FatTone (FH1410/1410S)
Lugs: STL65
Tension Rods: SST5047 Stainless Steel
Strainer: SR017
Snares: S022N

MCT1455S/C | 14" x 5.5"

Shell: 6 Ply Maple (5.4mm)
Hoops: SuperHoop II (SH1410B/1410S)
Lugs: CL55
Tension Rods: T062
Strainer: SR017
Snares: S022N



MCT1455S/C



MCT1465S/C

MCT1465S/C | 14" x 6.5"

Shell: 6 Ply Maple (5.4mm)
Hoops: SuperHoop II (SH1410B/1410S)
Lugs: CL65
Tension Rods: T061L
Strainer: SR017
Snares: S022N

STS1480S/C | 14" x 8"

Shell: 6-ply (5.4mm) Birch/African Mahogany
Hoops: SuperHoop II (SH1410B/1410S)
Lugs: CL100
Tension Rods: T061L
Strainer: SR017
Snares: S022N



STS1480S/C



STS1465S/C

STS1465S/C | 14" x 6.5"

Shell: 6-ply (5.4mm) Birch/African Mahogany
Hoops: SuperHoop II (SH1410B/1410S)
Lugs: CL65
Tension Rods: T061L
Strainer: SR017
Snares: S022N

STS1455S/C | 14" x 5.5"

Shell: 6-ply (5.4mm) Birch/African Mahogany
Hoops: SuperHoop II (SH1410B/1410S)
Lugs: CL55
Tension Rods: T062
Strainer: SR017
Snares: S022N



STS1455S/C



DMP1455S/C

DMP1455S | 14" x 5.5"

Shell: 6 Ply Maple (5.4mm)
Hoops: 1.6mm Steel (RH1408/1408S)
Lugs: NDL55/C
Tension Rods: TR5052
Strainer: SR700
Snares: SNW1420

FREE FLOATING

THE ULTIMATE PURITY OF SOUND



Tailored to bring power, clarity, and true articulation, Pearl's unique Free Floating Snare system removes all hardware from the shell to greatly improve the drum's resonance and projection.

TASK-SPECIFIC INNOVATION By combining the tonal character of each shell type with its ideally matched depth, each Free Floating snare drum is engineered to fit a specific task by model and gives you a unique voice for any sonic situation.



CLICK-LOCK THROW-OFF SYSTEM Engineered with Polymer bearings for precise and smooth action. Unique nylon grip mechanism locks the snares into place.

SEE AND HEAR
ALL 8 FREE FLOATING SNARE DRUMS
pearldrums.com/2minute



Deep, rich snare power with short, even sustain decay.
FTAL1480



Ultimate in throaty, deep snare growl. Shortened decay.
FTMH1480

FTAL1480 | 14" x 8"
Shell: 1.2mm Seamless Aluminum
Hoops: MasterCast (DC1410/DC1410S)
Lugs: FT80
Tension Rods: SST5042
Strainer: SR160F
Snares: SN1442C

FTMH1480 | 14" x 8"
Shell: 8 ply (10mm) African Mahogany
Hoops: MasterCast (DC1410/DC1410S)
Lugs: FT80
Tension Rods: SST5042
Strainer: SR160F
Snares: SN1442C



Lower overtone body, preserves crisp top-end snare snap.
FTPB1465



Full, rounded bottom frequencies. Extra midrange body.
FTMMH1465

FTPB1465 | 14" x 6.5"
Shell: 1.2mm Phosphor Bronze
Hoops: MasterCast (DC1410/DC1410S)
Lugs: FT65
Tension Rods: SST5042
Strainer: SR160F
Snares: SN1420C

FTMMH1465 | 14" x 6.5"
Shell: 6 ply (7.5mm)*
Hoops: MasterCast (DC1410/DC1410S)
Lugs: FT65
Tension Rods: SST5042
Strainer: SR160F
Snares: SN1420C
**4 ply Maple w/ 2 ply inner African Mahogany*



Full-spectrum, both bright in punch and warm in tone.
FTBR1450



Punchy and smooth. A perfect "go-to" snare.
FTMM1450

FTBR1450 | 14" x 5"
Shell: 1mm Brass
Hoops: MasterCast (DC1410/DC1410S)
Lugs: FT50
Tension Rods: SST5042
Strainer: SR160F
Snares: SN1420I

FTMM1450 | 14" x 5"
Shell: 6 ply (7.5mm) Maple
Hoops: MasterCast (DC1410/DC1410S)
Lugs: FT50
Tension Rods: SST5042
Strainer: SR160F
Snares: SN1420I



1mm shell for bright, open attack with ringy overtone.
FTSS1435



Dense all Birch shell delivers bright, open attack.
FTBB1435

FTSS1435 | 14" x 3.5"
Shell: 1mm Stainless Steel
Hoops: MasterCast (DC1410/DC1410S)
Lugs: FT35
Tension Rods: SST5035
Strainer: SR160F
Snares: SN1420D

FTBB1435 | 14" x 3.5"
Shell: 6 ply (5.4mm) Birch
Hoops: MasterCast (DC1410/DC1410S)
Lugs: FT35
Tension Rods: SST5035
Strainer: SR160F
Snares: SN1420D

SPACE-AGE PRECISION,
TIMELESS TONE

HYBRID EXOTIC

SEE AND HEAR
ALL 7 HYBRID EXOTIC SNARE DRUMS
pearldrums.com/2minute

The purest representation of Pearl's finest craftsmanship, Hybrid Exotic shell choices include spun-composite VectorCast™, dual-step seamless Cast Aluminum, and cross-laminated Kapur and Fiberglass, for the ultimate in power and prestige.

GLIDE-LOCK THROW-OFF SYSTEM Pearl's SR1000 Glide-Lock Strainer's locking throw-off lever and tension knob assures worry free, slip-free performance from all Hybrid Exotic Snare Drums. (U.S. Patent #7220905, #7301087, #7365256.)



Quick, yielding snap with heavy midrange overtones.
HEP1450



Full-Spectrum snare body with thick bottom-end tonality.
HEP1465

HEP1450 | 14" x 5"
Shell: VectorCast
Hoops: SuperHoop II (SH1410B/1410S)
Lugs: STL100
Tension Rods: SPT5047 (top) - SST5047 (bottom)
Strainer: SR1000
Snares: SN1420C

HEP1465 | 14" x 6.5"
Shell: VectorCast
Hoops: SuperHoop II (SH1410B/1410S)
Lugs: STL100
Tension Rods: SPT5047 (top) - SST5047 (bottom)
Strainer: SR1000
Snares: SN1420C



Dry, high-pitched crack with little overtone.
HEAL1450



Fat midrange focus without sacrificing volume.
HEAL1465

HEAL1450 | 14" x 5"
Shell: Cast Aluminum: 3mm w/ 2mm R-Rings
Hoops: SuperHoop II (SH1410B/1410S)
Lugs: STL100
Tension Rods: SPT5047 (top) - SST5047 (bottom)
Strainer: SR1000
Snares: SN1420I

HEAL1465 | 14" x 6.5"
Shell: Cast Aluminum: 3mm w/ 2mm R-Rings
Hoops: SuperHoop II (SH1410B/1410S)
Lugs: STL100
Tension Rods: SPT5047 (top) - SST5047 (bottom)
Strainer: SR1000
Snares: SN1420I



Articulate snare punch, best at higher tunings.
HEK1450



Lively blend of throaty snare holler and punchy projection.
HEK1465

HEK1450 | 14" x 5"
Shell: 6 ply 7.5mm Kapur w/Inner Fiberglass
Hoops: SuperHoop II (SH1410B/1410S)
Lugs: STL100
Tension Rods: SPT5047 (top) - SST5047 (bottom)
Strainer: SR1000
Snares: SN1420D

HEK1465 | 14" x 6.5"
Shell: 6 ply 7.5mm Kapur w/Inner Fiberglass
Hoops: SuperHoop II (SH1410B/1410S)
Lugs: STL100
Tension Rods: SPT5047 (top) - SST5047 (bottom)
Strainer: SR1000
Snares: SN1420D

SPIN-TIGHT™ TENSION RODS To maintain tuning tension across the batter head, all Hybrid Exotic snare drums feature Pearl's Spin-Tight tension rods. This elegantly simple innovation creates a tension rod-within-a-tension rod, that allows the rod to expand and lock into place within the swivel nut. Utilizing a special drum key, tunings can be controlled under high-impact play like never before.



HEK1480 | 14" x 8"
Shell: 6 ply 7.5mm Kapur w/Inner Fiberglass
Hoops: SuperHoop II (SH1410B/1410S)
Lugs: STL100
Tension Rods: SPT5047 (top) - SST5047 (bottom)
Strainer: SR1000
Snares: SN1442D

Low, thunderous wallop with deep, solid playability. **HEK1480**



Vital, immediate snare tone with an undeniably modern sensibility, Sensitone models in beaded Steel, Nickel-Plated Brass, and Seamless Aluminum deliver the goods with the right gig ready touches to make them a true professional standard.

Engineered for performance perfection, Sensi Tone Premium snare drums feature a choice of 14" models, available in 5" and 6.5" depths, in Patina Beaded Brass, Beaded Phosphor Bronze, or even-ly North American Maple shells. Additionally, the African Mahogany 15"x5" Baritone snare brings a deep, fresh voice to the tonal pallet.



Crisp, sensitive high-pitched snap.
STA1450S



Belting crack with mild midrange overtone.
STA1465S

STA1450S | 14" x 5"
Shell: 1mm Beaded Steel
Hoops: SuperHoop II (SH1410B/1410S)
Lugs: TB50
Tension Rods: SST5047
Strainer: SR150
Snares: SN1420I

STA1465S | 14" x 6.5"
Shell: 1mm Beaded Steel
Hoops: SuperHoop II (SH1410B/1410S)
Lugs: TB65
Tension Rods: SST5047
Strainer: SR150
Snares: SN1420I



Bright and responsive with lively overtone.
STA1450FB



Bold projection with controlled ring sustain.
STA1465FB

STA1450FB | 14" x 5"
Shell: 1.5mm Beaded Brass
Hoops: SuperHoop II (SH1410B/1410S)
Lugs: ARL55
Tension Rods: SST5047
Strainer: SR150
Snares: SN1420I

STA1465FB | 14" x 6.5"
Shell: 1.5mm Beaded Brass
Hoops: SuperHoop II (SH1410B/1410S)
Lugs: ARL65
Tension Rods: SST5047
Strainer: SR150
Snares: SN1420I



Perfect blend of attack and brassy body.
STA1450BR



An elegant solution for punch and warmth.
STA1465BR

STA1450BR | 14" x 5"
Shell: 1mm Beaded Brass
Hoops: SuperHoop II (SH1410B/1410S)
Lugs: TB50
Tension Rods: SST5047
Strainer: SR150
Snares: SN1420I

STA1465BR | 14" x 6.5"
Shell: 1mm Beaded Brass
Hoops: SuperHoop II (SH1410B/1410S)
Lugs: TB65
Tension Rods: SST5047
Strainer: SR150
Snares: SN1420I



Musical and penetrating with mid-range power.
STA1450PB



Bellowing low-end wallop with smooth articulation.
STA1465PB

STA1450PB | 14" x 5"
Shell: 1.2mm Phosphor Bronze
Hoops: SuperHoop II (SH1410B/1410S)
Lugs: ARL55
Tension Rods: SST5047
Strainer: SR150
Snares: SN1420I

STA1465PB | 14" x 6.5"
Shell: 1.2mm Phosphor Bronze
Hoops: SuperHoop II (SH1410B/1410S)
Lugs: ARL65
Tension Rods: SST5047
Strainer: SR150
Snares: SN1420I



Dry, focused crack with quick decay.
STA1450AL



Full, guttural snare bellow with little overtone.
STA1465AL

STA1450AL | 14" x 5"
Shell: 1.2mm Beaded Seamless Aluminum
Hoops: SuperHoop II (SH1410B/1410S)
Lugs: TB50
Tension Rods: SST5047
Strainer: SR150
Snares: SN1420I

STA1465AL | 14" x 6.5"
Shell: 1.2mm Beaded Seamless Aluminum
Hoops: SuperHoop II (SH1410B/1410S)
Lugs: TB65
Tension Rods: SST5047
Strainer: SR150
Snares: SN1420I



Top-end projection with fat highs and mids.
STA1450MM



Thick snare tone with suppressed mid-tonality.
STA1465MM

STA1450MM | 14" x 5"
Shell: 6 ply 5.4mm Maple
Hoops: SuperHoop II (SH1410B/1410S)
Lugs: ARL55
Tension Rods: SST5047
Strainer: SR150
Snares: SN1420D

STA1465MM | 14" x 6.5"
Shell: 6 ply 5.4mm Maple
Hoops: SuperHoop II (SH1410B/1410S)
Lugs: ARL65
Tension Rods: SST5047
Strainer: SR150
Snares: SN1420D

**THROW-OFF SYSTEM:
SR150 STRAINER**

The secret behind Pearl's patent pending Click-Lock Strainer System is a "C"-shape clip that clicks onto the tension dial. This prevents the lever from disengaging, and the tension dial from loosening, even if the tension is very low. A Polymer bearing on the axle provides smooth and accurate action, and reliably quick response from the lever. (U.S. Patent #9082376)

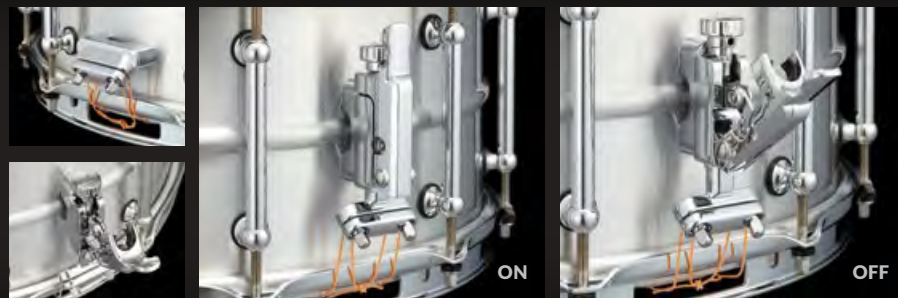

The stylish Arch-Tube Lug features a low contact design with separate self-aligning swivel nuts for pristine tuning across the head and reduced binding within the lug. (U.S. Patent #9502013)



The Baritone Snare; low end tone with top end snap.
STA1550MH

STA1550MH | 15" x 5"
Shell: 4 Ply 5mm African Mahogany*
Hoops: SuperHoop II (SH1510B/1510S)
Lugs: ARL55
Tension Rods: SST5047
Strainer: SR150
Snares: SN1520I

*w/ Maple Reinforcement Rings

Sensi Tone Premium's selection of refined percussion instruments are sure to be first call drums for the stage, studio, and beyond.

BRIAN FRASIER-MOORE



“ In my opinion, a great snare drum provides power, tone and versatility, I'm proud to say that we've accomplished these things with my Pearl Signature Snare. If you're looking for that complete sound, then this is the snare for you. ”

- BRIAN FRASIER-MOORE

BFM1455S/C | 14" x 5.5"

Shell: 12-Ply, 15mm Gum/Maple/Gum
Hoops: MasterCast (DC1410/DC1410S)
Lugs: CL55
Tension Rods: T062
Strainer: SR150
Snares: SN1442I
Finish: Gloss Gumwood Naturalburst



IAN PAICE



IP1465 | 14" x 6.5"

Shell: Beaded Steel Shell
Hoops: SuperHoop II (SH1410B/1410S)
Lugs: TB65
Tension Rods: SST5042 Stainless Steel
Strainer: SR017
Snares: S022N
Finish: Chrome-Plated



JOEY JORDISON



JJ1365N | 13" x 6.5"

Shell: Steel Shell
Hoops: SuperHoop II (SHB1308/1308S)
Lugs: CL65B
Tension Rods: SST5047 Stainless Steel
Strainer: SR017/B
Snares: S029N
Finish: Custom Black



DENNIS CHAMBERS



DC1450S/N | 14" x 5"

Shell: Cast Aluminum: 3mm w/ 2mm R. Rings
Hoops: SuperHoop II (SHN1412B/1408S)
Lugs: STL100
Tension Rods: SST5047 Stainless Steel
Strainer: SR020 Multi-Trace Strainer System
Snares: SN1420I
Finish: Black Nickel Shell w/ Nickel Hardware



OMAR HAKIM



OH1350 | 13" x 5"

Shell: 6 ply African Mahogany Shell
Hoops: SuperHoop II (SH1308/1308S)
Lugs: CL55
Tension Rods: SST5047 Stainless Steel
Strainer: SR015
Snares: S029N
Finish: #140 Natural Mahogany



UTILITY

VERSATILE DRUMS FOR SECONDARY EFFECTS



MODERN UTILITY snare drums are vital instruments. Well-appointed tools of the trade crafted for the informed, current drummer to make the gig great. Priced for the active working player, Modern Utility snares are available in both 100% Maple and Beaded Steel. Flexible enough to add to any setup and strong enough to stand up to constant play, each model has a cool, versatile vibe. Featuring our CL arch lugs and smooth SR700 snare strainer for precise tunability.



See Korn drummer Ray Luzier's performance test of each Modern Utility snare at pearldrums.com



MUS1480M/C



MUS1410FM/C Leg Brackets: FTB07 (x3)

MUS1480M/C | 14" x 8"
Shell: 6 ply Maple (5.4mm)
Hoops: 1.6mm Steel (RH1408/1408S)
Lugs: CL100
Tension Rods: TR5047 (16)
Strainer: SR700
Snares: SNW1420
Finishes: #224 Matte Natural, #227 Satin Black

MUS1410FM/C | 14" x 10"
Shell: 6 ply Maple (5.4mm)
Hoops: 1.6mm Steel (RH1408/1408S)
Lugs: CL100
Tension Rods: TR5052 (16)
Strainer: SR017
Snares: SNW1420
Finishes: Satin Brown (#220)



MUS1455M/C



MUS1465M/C

MUS1455M/C | 14" x 5.5"
Shell: 6 ply Maple (5.4mm)
Hoops: 1.6mm Steel (RH1408/1408S)
Lugs: CL55
Tension Rods: TR5052 (16)
Strainer: SR700
Snares: SNW1420
Finishes: #224 Matte Natural, #227 Satin Black

MUS1465M/C | 14" x 6.5"
Shell: 6 ply Maple (5.4mm)
Hoops: 1.6mm Steel (RH1408/1408S)
Lugs: CL65
Tension Rods: TR5047 (16)
Strainer: SR700
Snares: SNW1420
Finishes: #224 Matte Natural, #227 Satin Black



MUS1350M/C



MUS1270M/C

MUS1350M/C | 13" x 5"
Shell: 6 ply Maple (5.4mm)
Hoops: 1.6mm Steel (RH1308/1308S)
Lugs: CL55
Tension Rods: TR5047 (16)
Strainer: SR700
Snares: SNW1316
Finishes: #224 Matte Natural, #227 Satin Black

MUS1270M/C | 12" x 7"
Shell: 6 ply Maple (5.4mm)
Hoops: 1.6mm Steel (RH1206/1206S)
Lugs: CL65
Tension Rods: TR5057 (12)
Strainer: SR017
Snares: SNW1216
Finishes: #224 Matte Natural, #227 Satin Black



MUS1455S/C



MUS1465S/C

MUS1455S/C | 14" x 5.5"
Shell: 1mm Beaded Steel
Hoops: 1.6mm Steel (RH1408/1408S)
Lugs: CL55
Tension Rods: TR5052 (16)
Strainer: SR700
Snares: SNW1420
Finishes: Textured Steel

MUS1465S/C | 14" x 6.5"
Shell: 1mm Beaded Steel
Hoops: 1.6mm Steel (RH1408/1408S)
Lugs: CL65
Tension Rods: TR5047 (16)
Strainer: SR700
Snares: SNW1420
Finishes: Textured Steel

EFFECTS



CC1450S/C | 14" x 5"
Shell: 6-ply 6.8mm Poplar/Maple
Hoops: 1.6mm Steel (RH1408/1408S)
Lugs: CL55
Tension Rods: TR5047 (16)
Strainer: SR700
Snares: SNW1420
Finishes: Artisan II Flame Wrap

THE IGNITER To capture the searing energy of drumming for a new generation of players, Pearl collaborated with viral video drummer Casey Cooper to create The Igniter. Specifically created to instantly improve the sound of any student drum kit, it's a fantastic value to keep the fire of drumming burning bright!



CASEY COOPER @COOP3DRUMM3R

COLLABORATION



EFFECTS



M1060 | 10" x 6"

Shell: 6 Ply Maple (7.5mm)
Hoops: Super Hoop II (SH1006/1006S)
Lugs: CL65
Tension Rods: SST5035 (12)
Strainer: SR018
Snares: S032N



M1270 | 12" x 7"

Shell: 8 Ply Maple (10mm)
Hoops: 1.6mm Steel (RIM1208B/1208S)
Lugs: CL100
Tension Rods: SST5047 Stainless Steel (16)
Strainer: SR018
Snares: S031N



Bracket & Mount Included

SFS10/C31 | 10" x 4.5"

Shell: 6 Ply Poplar
Hoops: 1.6mm Steel (RIM1006RSH/RIM1006RSH)
Lugs: MSFL35
Tension Rods: RSHT3240 (12)
Strainer: SR02MSFL/SR02EMSFL
Snares: SN10MSFL

PICCOLO



B1330 | 13" x 3"

Shell: 1.0mm Brass
Hoops: 1.6mm Steel (RIM1308B/1308S)
Lugs: CL05
Tension Rods: T055 (16)
Strainer: SR018
Snares: S029N



S1330B | 13" x 3"

Shell: 1.0mm Black-finish Steel
Hoops: 1.6mm Steel (RIM1308B/1308S)
Lugs: CL05
Tension Rods: T055 (16)
Strainer: SR018
Snares: S029N



M1330 | 13" x 3"

Shell: 6ply Maple (7.5mm)
Hoops: 1.6mm Steel (RIM1308B/1308S)
Lugs: CL05
Tension Rods: T055 (16)
Strainer: SR018
Snares: S029N

FIRECRACKER



FCP1250 | 12" x 5"

Shell: 8 ply Poplar (10mm)
Hoops: 1.6mm Steel (RIM1206/1206SL)
Lugs: CL50
Tension Rods: T061L (12)
Strainer: SR018
Snares: S031



FCS1050 | 10" x 5"

Shell: 1.0mm Steel
Hoops: 1.6mm Steel (RIM1006/1006SL)
Lugs: CL50
Tension Rods: T061L (12)
Strainer: SR018
Snares: S032

- Single Pedal Complete P3000D
- Double Pedal Complete (right footed) P3002D
- Double Pedal Conversion Kit (right footed) P3001D
- Double Pedal Complete (left footed) P3002DL

DEMON DRIVE

UNLEASH THE DEMON

Demon Drive's lightning fast power and silky smooth finesse make it the choice of the drumming world's most prolific players. Featuring an amazing array of adjustable features, from beater angle, traction plate grip, and footboard height and angle, Demon Drive truly becomes an extension of your body. Its totally modular design makes it configurable in a variety of single and double pedal setups. Unleash the Demon and find out what custom feel is all about.

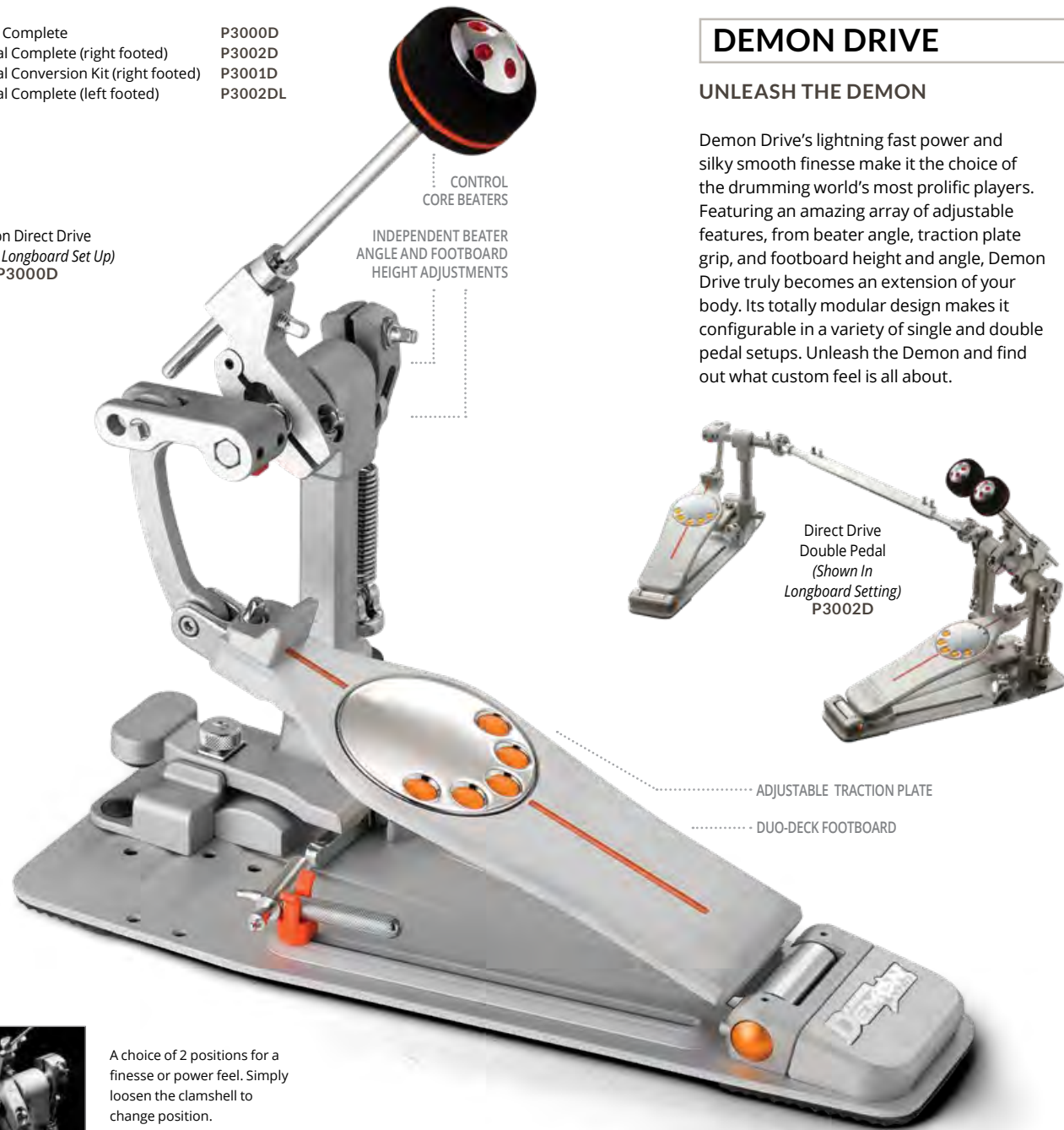

EQUIPMENT FAILURE IS NOT AN OPTION, END OF STORY.

Pearl's hardware is LEGENDARY. So rugged, sure-footed, and built to last that we back it up with PEARL'S EXCLUSIVE Lifetime Warranty.



DEMON CHAIN

TRADITIONAL FEEL AND POWER OF A CHAIN

An innovative combination of Demon Drive speed and traditional chain drive feel, the Demon Chain's Perfect Circle cam delivers smooth, consistent response throughout the stroke for pinpoint accuracy and control. A high performance package for the driven power drummer.

- Single Pedal Complete P3000C
- Double Pedal Complete (right footed) P3002C
- Double Pedal Conversion Kit (right footed) P3001C
- Double Pedal Complete (left footed) P3002CL



A choice of 2 positions for a finesse or power feel. Simply loosen the clamshell to change position.

U.S. Patent #7579540



DIRECT LINK Dual position adjustment for LIGHT or HEAVY feel, creating a seamless link between your foot and the bass drum.

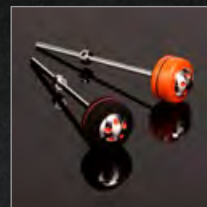

DEMON DRIVE BEATER w/ Control Core Elastomer Center: Reduces impact vibration. (U.S. Patent #7626108)



CLICK-LOCK Secures spring tension in high impact play. (U.S. Patent #7754953)



DUO-DECK FOOTBOARD The world's first convertible footboard can switch from a traditional shortboard to a longboard pedal in seconds. (U.S. Patent #7626107)



NINJA BEARINGS Designed for Pro Skateboarding, each bearing features micro-polished balls for minimal friction and unmatched speed.



PERFECT CIRCLE CAM Its racing inspired lines transfer energy from your foot into the head with minimal mass and maximum speed.



POWER CHAIN This ultra lightweight, dual linkage Chain features low friction rollers for power and dependability.



P3002C Chain Drive Double Pedal (Shown In Shortboard Setting)



Z-LINK DRIVE SHAFT Delivering the same precise action of the primary pedal in the secondary pedal, the Z-Link features hand assembled, CNC machined construction. Features Pearl's exclusive Zero Latency Universal Joints, and precision radial ball bearings.



MICHEL'LE BAPTISTE
NORMANI/ADAM LAMBERT



Eliminator Redline
Single Pedal, Chain Drive
P2050C

CHOOSE A CAM

REDLINE YOUR PERFORMANCE

The world's only pedal featuring the Patented Interchangeable Cam System, Eliminator: Redline's virtually unlimited tunability lets you lock in personally tuned feel, power, and speed. Like having four pedals in one, Redline pushes the boundaries of bass drum performance by fusing the power and flexibility of Pearl's original Eliminator with the fluid speed of our Demon series pedals.



INTERCHANGEABLE CAM SYSTEM

Provides a choice of 6 different color-coded cams (4 included and 2 more optional). Quickly changes the power and feel of the pedal to suit your individual playing needs. Changing the cam is as simple as pushing the release button and snapping another in place.

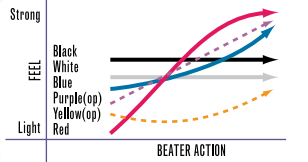

BLACK CAMTBK Linear action cam
WHITE CAMTWT Oversized linear cam
BLUE CAMTBL Progressive cam
RED CAMTRD Radical progressive cam
PURPLE CAMPL Aggressive action cam (Optional)
YELLOW CAMYL Inverse action cam (Optional)

CHAIN OR BELT DRIVE

The sprocket-less double chain drive on the Eliminator Redline (P2050C) provides super smooth action with powerful and precise feel. The Eliminator Belt Drive model (P2050B) provides a very comfortable, natural feel similar to a direct-drive system.

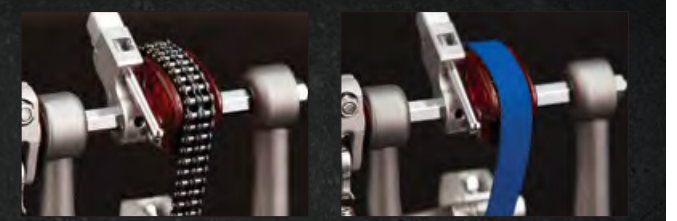

*Shown w/ Optional Red Cam

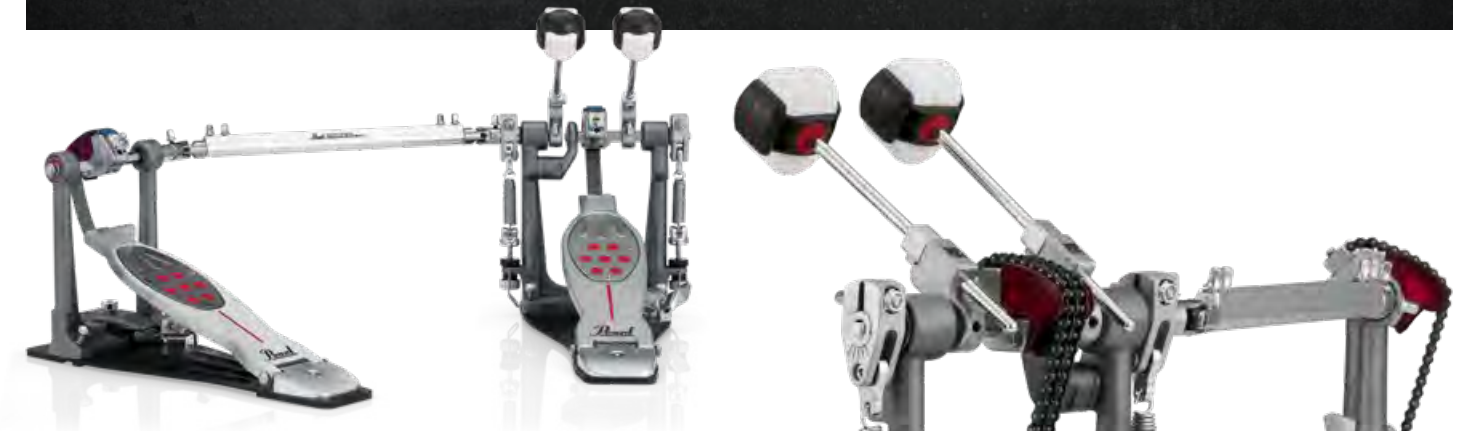

Eliminator Redline Double Pedal, Belt Drive
P2052B

Eliminator Redline Double Pedal Chain Drive (Shown w/ Included Red Cam Attached)
P2052C



Eliminator Redline Series pedals come standard with Custom Carry bags.



INDEPENDENT TRACTION GRIPS
Features Pearl's exclusive reversible Traction Plate and individual traction grips, configurable to suit your individual taste.



ZERO PLAY HINGE Our proprietary stainless-steel hinge provides maximum freedom of motion and prevents play between the footboard and heel.
U.S. Patent #7179978



NiNja BEARINGS Designed for Pro Skateboarding, each bearing features micro-polished balls for minimal friction and unmatched speed.



ROLLER HOOP CLAMP Features side mount adjustment for easy set-up and tear down. Quickly adapts to a wide range of hoop thicknesses smooth, secure grip.



THE CONTROL CORE QUADBEATER
Provides four beater surfaces (two hard plastic, two felt) with the added feel of the vibration-free Control Core elastomer center.
U.S. Patent #5610351
U.S. Patent #7626108



POWERSHIFTER FUNCTION Provides forward (light), center (standard), or rear (strong) positions to instantly fine tune pedal feel and power transfer.
U.S. Patent #5574237

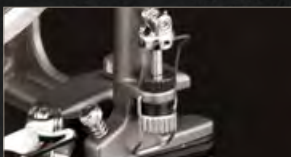

CLICK-LOCK SPRING ADJUSTMENT
Secures spring tension in high impact play. The counter spring adjustment's rolling cradle allows the spring to pivot with each stroke for less resistance.
U.S. Patent #7754953



UNI-LOCK BEATER ANGLE CAM
Grips the axle a full 360 degrees, allowing infinite beater angle adjustments. Floating Spring Pendulum design is perfectly centered on the clamp for full bearing movement and maximum smoothness.

ELIMINATOR SOLO: BLACK

SINGULAR FEEL. ELIMINATOR SPEED. PRICED TO PERFORM.

Delivering blinding speed and powerful performance, Eliminator Solo bass drum pedals put the fleet footed player in control with all the gliding velocity that made Pearl pedals revolutionary. These no nonsense, streamlined Eliminator models deliver singular, resistance free feel for effortless play and driving performance.

The Solo: Black pedal's even, slightly weighted feel delivers just the right amount of resistance without slowing your stroke - for increased power and less muscle fatigue.



Eliminator Solo: Black
P1030

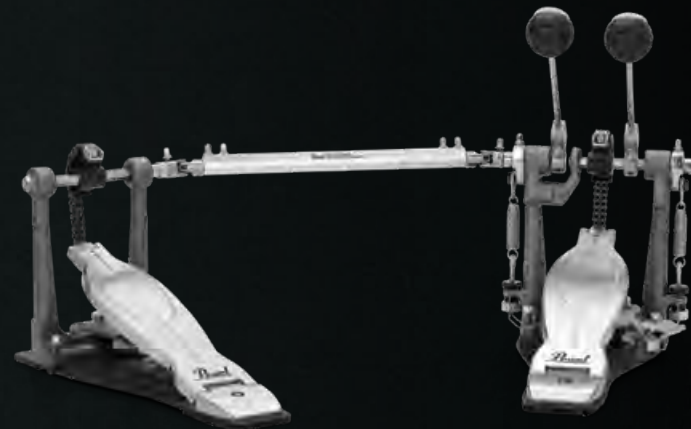

Eliminator Solo: Black
Double Pedal
P1032

ELIMINATOR SOLO: RED

With traditional feel similar to the Radical Progressive Action of the Red cam, the Solo: Red model has an accurate, resistance-free feel to deliver effortless action with accentuated rebound.

The shape of the Red cam allows the dual-chain drive to match the motion of your foot and deliver a fast, fluid stroke for longer play and less fatigue.



Eliminator Solo: Red
P1030R

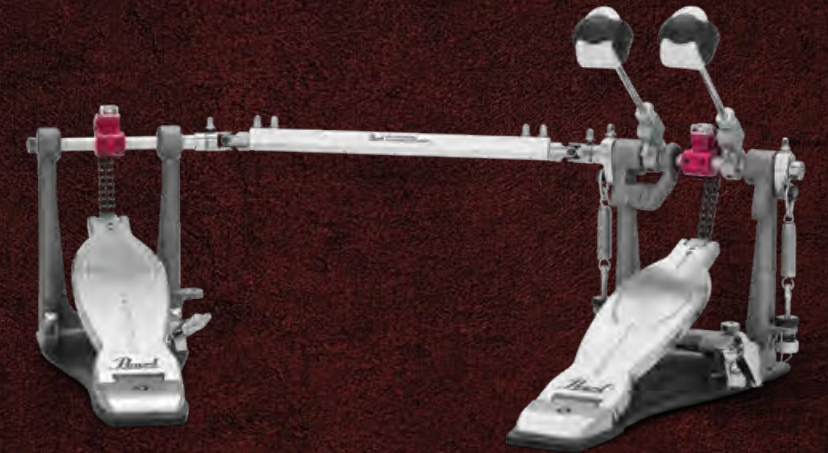

Eliminator Solo: Red
Double Pedal
P1032R

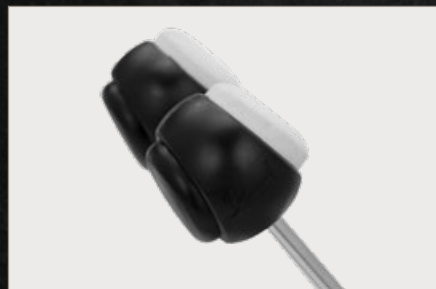

CONTROL CORE DUOBEATER
Provides hard and soft beater surfaces with the added feel of the vibration free Control Core elastomer center.
U.S. Patent #7626108



ROLLER HOOP CLAMP Features side mount adjustment for easy set-up and tear down. Quickly adapts to a wide range of hoop thicknesses smooth, secure grip.



CONTROL CORE QUADBEATER
Provides four beater surfaces (two hard plastic, two felt) with the added feel of the vibration-free Control Core elastomer center.
U.S. Patent #5610351,
U.S. Patent #7626108



UNIVERSAL JOINT
All Eliminator Solo pedals come with Pearl's adjustable Universal Drive Joint, giving the secondary pedal the feel, power, and unrestrained feel of the main pedal.



Single Pedal Complete P930



SEE AND HEAR
THE P930 & P932 DRUM PEDALS
pearldrums.com/2minutepedals

CONTROL CORE DUO BEATER
BEATER HEIGHT ADJUSTMENT
INTERCHANGEABLE CAM TECHNOLOGY
INFINITE BEATER ANGLE ADJUSTMENT

2 POSITION POWERSHIFTER FUNCTION

CLICK LOCK SPRING TENSION

- Single Pedal Complete P930
- Double Pedal Complete (right footed) P932
- Double Pedal Conversion Kit (right footed) P931
- Double Pedal Complete (left footed) P932L

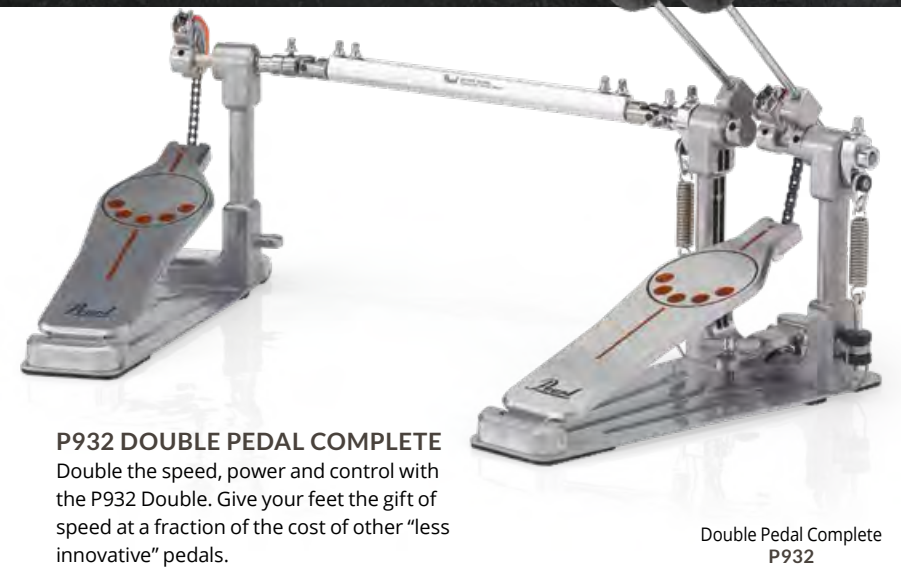

P932 DOUBLE PEDAL COMPLETE
Double the speed, power and control with the P932 Double. Give your feet the gift of speed at a fraction of the cost of other "less innovative" pedals.

Double Pedal Complete P932

SUPER SMOOTH, EXTREMELY FAST!
Merging quick rebound response of our flagship Demon Drive with the finely-tuned control of our award-winning Eliminator models, the P930 bass drum pedal offers high-end performance at a player accessible price. Its longboard playing deck delivers a lighter feel for increased speed, and offers advanced performance control and tunability with two rotor cam options. The ultimate pedal for fast feet on a budget.

CONTROL CORE DUO BEATER (U.S. Patent #7626108) utilizes an elastomer center to minimize vibration and features two unique playing surfaces (rounded felt and convex hard plastic surface) for quick-shifting tone and feel.

POWERSHIFTER FUNCTION (U.S. Patent #5574237) further tunes the power, feel, and leverage of the pedal by shifting the chain angle forward for lighter feel, or back for increased power.

Comes standard with Perfect Circle and removable Orange Progressive Cams, for fully tunable performance and increased control.



ORANGE PROGRESSIVE CAM can be removed to reveal the Perfect Circle for further tunability to match your playing style. U.S. Patent #6172291



The P930 pedal is included as an upgrade in the 830 Series hardware pack and comes with Export and Export Lacquer drum sets.

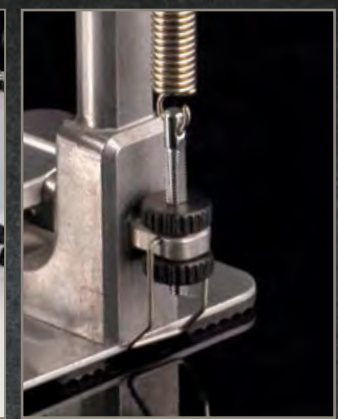

CLICK-LOCK SPRING TENSION maintains perfect tension gig after gig. Set it and forget it. U.S. Patent #7754953

SPEED, POWER, AND VALUE

P530 DRUM PEDAL

With all the speed and function of a pro bass drum pedal at half the price, Pearl's P530 Bass Drum Pedal features a dual chain and Linear Action cam drive for smooth, traditional pedal action and speed.



Single Pedal Complete P530

The radius rod frame makes it highly portable for gigging, while features like a two surface DuoBeater and rotor tension axle clamp make it adaptable to virtually any feel or playing style.

P830 DRUM PEDAL

Light in weight but not in features, the P830's Demon-style longboard increases playing surface for maximum leverage and speed. Its fully adjustable beater angle, Perfect Circle single chain cam, and DuoBeat two-surface beater deliver customizable feel for the player on the move.



Single Pedal Complete P830

HI-HAT STANDS

BIGGEST ADVANCEMENT IN TIME-KEEPING SINCE THE WRISTWATCH

BRIAN FRASIER-MOORE
JUSTIN TIMBERLAKE



OKWA ANDREWS
BRIAN'S TECH

“Night in and night out, Pearl hardware keeps everything right where it should be, and without fail!”
- OKWA ANDREWS

H2050

Sharing many of the key characteristics of Pearl's Eliminator Redline bass drum pedals, 2050 Series Hi-Hat Stands deliver unparalleled versatility and customization in hi-hat pedal control. The world's-only hi-hat stand featuring the Interchangeable Cam System, 2050 Series stands' customizable options are designed to eliminate resistance, reduce fatigue, and increase performance.

RH2050

The RH2050 Remote Hi-Hat's low-friction cable produces smooth, lag-free performance with the lightning-fast action of the PosiLink Twin Cam drive system. Fast, natural-feeling cymbal play is finally accessible virtually anywhere on the kit, or to facilitate multiple hi-hat system setups.



CLH930
 • Closed Hi-Hat
 • Uni-Lock Tilter
 • Knurled Boom Arm
 • UltraGrip Wing Nuts / Wing Bolts

H2050
 • Rapid Lock Super Grip Clutch (U.S. Patent #9355625)
 • Hi-Hat Cup (U.S. Patent #7078606)
 • Swiveling Legs
 • Precision Spring Tension Dial
 • PosiLink Twin Cam Drive System with Interchangeable Cams
 • Traction Plate
 • Footboard Convertible Spike/Rubber Feet (U.S. Patent #7371953)
 • Footboard Docking Station
 • PowerShifter
 • Height range of 750-1030mm

Pearl's Rapid Lock Super Grip's slip-proof clutch system features a patented 360° lock nut that provides vice-like clamping force for a super grip. (U.S. Patent #9355625)



RH2050
 • Rapid Lock Clutch (U.S. Patent #9355625)
 • Direct Pull Drive System
 • Infinitely Adjustable Footboard Angle
 • Double Braced Tripod w/ Swivel Function
 • Spike/Rubber Tips
 • Spring Tension Dial
 • Hi-Hat Cup (U.S. Patent #7078606)



H1050
 • Rapid Lock Clutch (U.S. Patent #9355625)
 • Direct Pull Drive System
 • Infinitely Adjustable Footboard Angle
 • Double Braced Tripod w/ Swivel Function
 • Spike/Rubber Tips
 • Spring Tension Dial
 • Hi-Hat Cup (U.S. Patent #7078606)
 • Height range of 700-960mm

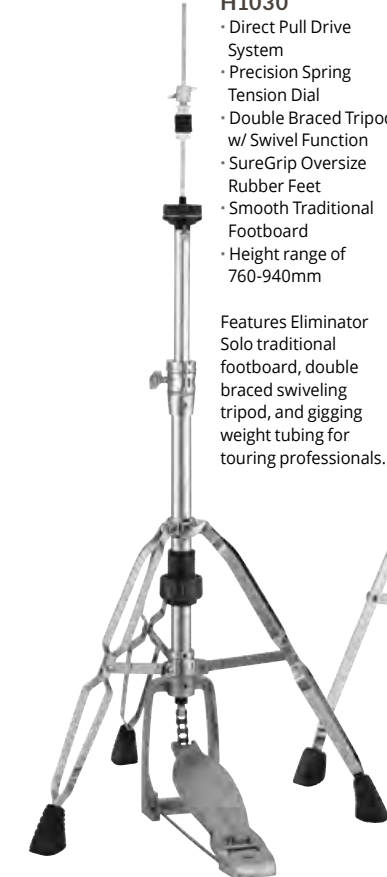

H1030
 • Direct Pull Drive System
 • Precision Spring Tension Dial
 • Double Braced Tripod w/ Swivel Function
 • SureGrip Oversize Rubber Feet
 • Smooth Traditional Footboard
 • Height range of 760-940mm

 Features Eliminator Solo traditional footboard, double braced swiveling tripod, and gigging weight tubing for touring professionals.



H1030S
 • Direct Pull Drive System
 • Precision Spring Tension Dial
 • Single Braced Tripod w/ Swivel Function
 • Smooth Traditional Footboard
 • Height range of 760-940mm

 Features Eliminator Solo traditional footboard, single braced swiveling tripod, and reduced weight for gigging professionals.



H930
 • Direct Pull Drive System
 • Precision Spring Tension Dial
 • Double Braced Tripod w/ Swivel Function
 • SureGrip Oversize Rubber Feet
 • Demon Style Long Board Footboard
 • Height range of 760-940mm



H830
 • Demon Style Long Footboard (single color footboard)
 • Double Braced Tripod w/ Swivel Function
 • Height range of 610-910mm

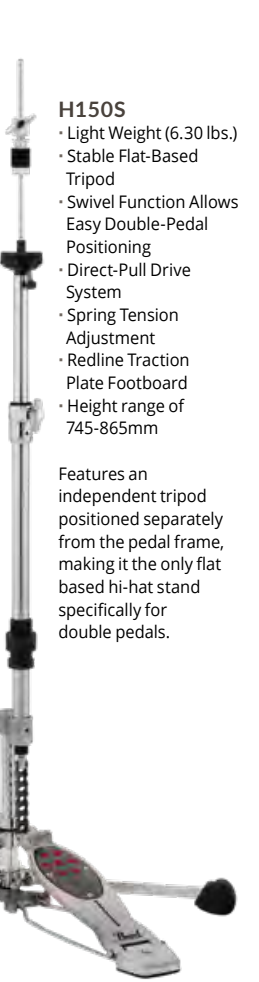

H150S
 • Light Weight (6.30 lbs.)
 • Stable Flat-Based Tripod
 • Swivel Function Allows Easy Double-Pedal Positioning
 • Direct-Pull Drive System
 • Spring Tension Adjustment
 • Redline Traction Plate Footboard
 • Height range of 745-865mm

 Features an independent tripod positioned separately from the pedal frame, making it the only flat based hi-hat stand specifically for double pedals.



INDEPENDENT TRACTION GRIPS features Pearl's exclusive reversible Traction Plate and individual traction grips, configurable to suit your individual taste.



H2050 PRECISION SPRING TENSION DIAL allows perfect tension control for fine-tuned response.



H1050 PEDAL HEIGHT ADJUSTMENT The infinite footboard angle adjustment featured on the H2050 and H1050 allows precise height matching in multi-pedal setups.



CLAMSHELL CLAMP The H2050, H1050, H1030, H1030S, and H930 Hi-Hat Stand uses beefy 1" tubing and clamshell clamps with built in memory locks for superior rigidity.



HA130 positions your hi-hat next to your bass pedal in double bass set-ups for effortless transitions between pedals.

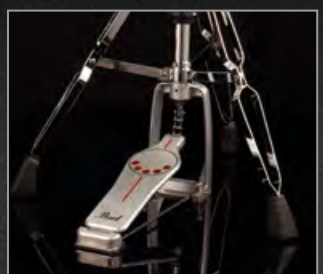

H930 HI-HAT STAND H930 Hi-Hat Stand features our Demon style longboard, double braced tripod w/ swivel function, and precision tension dial.



H830 HI-HAT STAND H830 Hi-Hat Stand is standard equipment with our Export series and offers a monochromatic Demon Style longboard design and swivel tripod.



H150S* FLAT-BASED SWIVELING HI-HAT The H150S independent tripod is positioned separately from the pedal frame making it the only flat-based hi-hat stand with swiveling legs.
*Toe Stopper Not Included

SNARE STANDS

EVERY SNARE SHOULD BE SO LUCKY

No matter the gig or the drum, Pearl has a stand to accommodate both with security, high function, and chameleon-like diversity.



The S930 offers similar features but uses our legendary Uni-Lock tilter and is also available as a drop basket version.

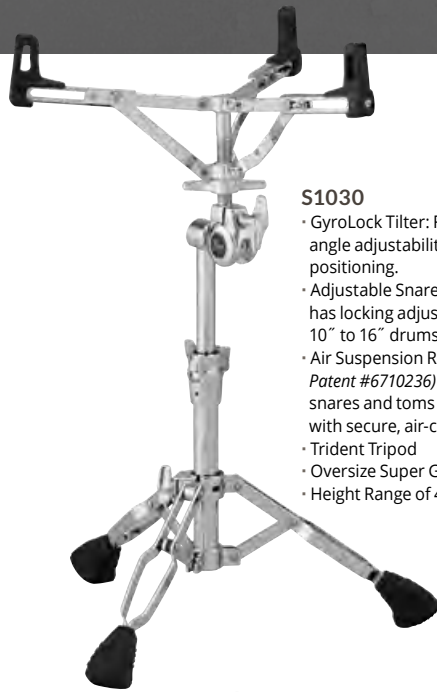

S1030

- GyroLock Tilter: Features infinite angle adjustability for pinpoint positioning.
- Adjustable Snare Basket: Each arm has locking adjustment rail to fit 10" to 16" drums.
- Air Suspension Rubber Tips (U.S. Patent #6710236) Allows prized snares and toms to fully resonate with secure, air-cushioned grips.
- Trident Tripod
- Oversize Super Grip Rubber Feet
- Height Range of 480-700mm



S930

- Uni-Lock Tilter
- Air Suspension Rubber Tips (U.S. Patent #6710236)
- Double Braced Trident Style Tripod
- Fits Snares 10" - 14"
- Height Range of 450-670mm

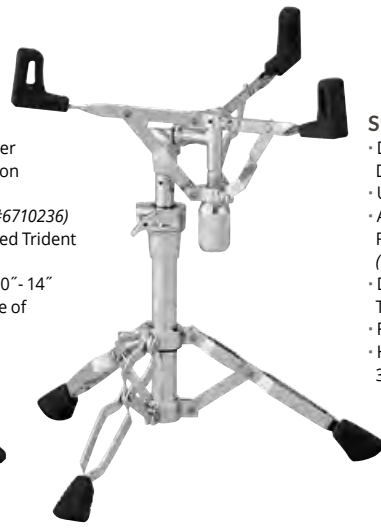

S930D

- Drop Basket for Deeper Snares
- Uni-Lock Tilter
- Air Suspension Rubber Tips (U.S. Patent #6710236)
- Double Braced Trident Style Tripod
- Fits Snares 10" - 14"
- Height Range of 360-570mm

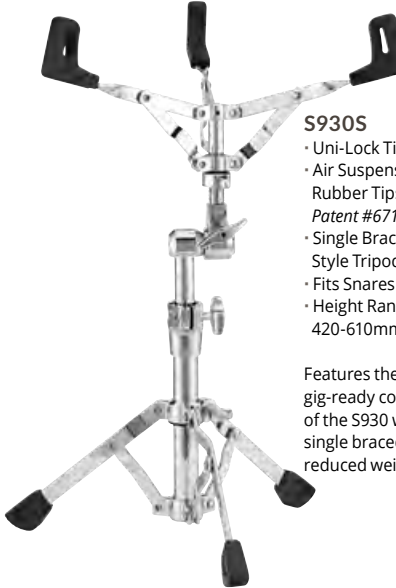

S930S

- Uni-Lock Tilter
- Air Suspension Rubber Tips (U.S. Patent #6710236)
- Single Braced Trident Style Tripod
- Fits Snares 10" - 14"
- Height Range of 420-610mm

Features the same gig-ready construction of the S930 with single braced legs for reduced weight.



S830

- Uni-Lock Tilter
- Double Braced Tripod
- Fits Snares 13" - 14"
- Height Range of 440-650mm

Standard equipment with Export Series drums, its lightweight yet rigid construction is perfect for local gigging and easy transport.

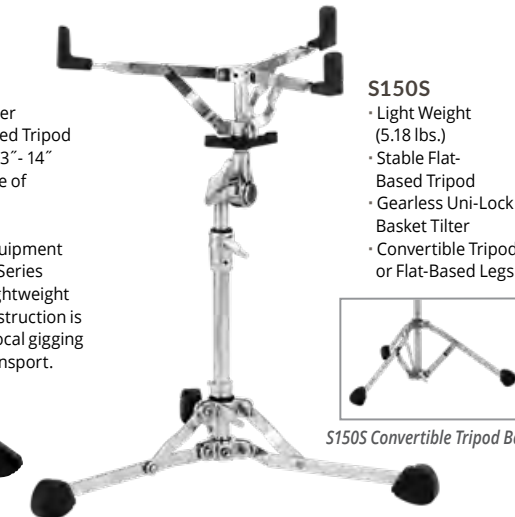

S150S

- Light Weight (5.18 lbs.)
- Stable Flat-Based Tripod
- Gearless Uni-Lock Basket Tilter
- Convertible Tripod or Flat-Based Legs



S150S Convertible Tripod Base

Features an independent single-braced tripod, making it instantly convertible from flush-based to standard tripod.



S1030 SNARE STAND GYROLOCK Our premier S1030 model features Pearl's 360 degree infinitely adjustable GyroLock tilter for ease-of-use and pinpoint positioning.



S1030 SNARE BASKET The Pearl S1030 Snare Stand adjusts to fit virtually any size snare from 10" to 16". The Air Suspension rubber tips securely cradle your prized snares while allowing them to fully resonate. (U.S. Patent #6710236)



S930D SNARE BASKET The S930D Snare Stand is a shorter version of the S930 Snare Stand, and is built to comfortably accommodate deeper snare drums.



SPIKED / RUBBER FEET Our CVT300/3 Push Button Spiked/Rubber Feet come in pack of 3 to retrofit on any of our 1030 Series hardware for sure-footed performance on any terrain. (U.S. Patent #7371953)

SOUND ERGONOMICS

DRUM THRONES



Essential for extended and efficient performance, the right throne will prevent fatigue and promote great form and posture to keep you playing your best, night after

night. Pearl thrones feature advanced ergonomic design and a selection of computer-tempered cushion tops to provide support and ease joint pressure during long sessions.

Multi-Core Foam Technology: Roadster thrones now feature multiple layers of varied density foam which combine for a better playing foundation and improved feel.



D3500BR

- Saddle-Style, Multi-Core Foam Cushion
- Detachable Backrest Mounts via Single Knob
- Lock/Spin System: Reversible StopLock allows cushion to be secured in place or free spinning depending on preference.
- Height Range of 495-665mm



D3500

- Saddle-Style, Multi-Core Foam Cushion
- Accepts Optional Backrest
- Lock/Spin Reversible StopLock System
- Height Range of 495-665mm



D1500TGL

- 15" Trilateral Multi-Core Foam Cushion
- Option of a Saddle or Round top feel.
- Accepts Optional Backrest
- Gas Lift Height Adjustment
- Lightweight Aluminum Struts: Solid support with easier transport.
- Height Range of 495-695mm



D1500RGL

- 15" Round Multi-Core Foam Cushion
- Accepts Optional Backrest
- Gas Lift Height Adjustment
- Lightweight Aluminum Struts
- Height Range 495-695mm



D1500SP

- 15" Vented Round Seat
- Multi-Core Foam Donut Cushion
- Accepts Optional Backrest
- Built-In Shock Absorber Post w/ Adjustable Spring Tension
- Lock/Spin Reversible StopLock System
- Height Range of 525-630mm



D1500

- 15" Vented Round Seat
- Multi-Core Foam Donut Cushion
- Accepts Optional Backrest
- Lock/Spin Reversible StopLock System
- Height Range 495-665mm



D1500S

- 15" Vented Round Seat
- Multi-Core Foam Donut Cushion
- Accepts Optional Backrest
- Lock/Spin Reversible StopLock System
- Height Range 445-615mm



DTBR1535

- 12.5" x 7" Optional Backrest
- Formfitting and Breathable
- Removable
- Dual Axis Adjustability



D930

- Round Vinyl Cushion
- Double Braced Legs
- Height Range of 470-660mm



D790

- Round Vinyl Cushion
- Height Range of 430-650mm



D730S

- Round Vinyl Cushion
- Single Braced Tripod
- Height Range of 405-605mm



D50

- Round Vinyl Cushion
- Double Braced Tripod
- Height Range of 495 - 620mm

CYMBAL STANDS

WELCOME TO BOOM TOWN

Your hardware has to work as hard you do, and Pearl's strong, gig ready stands and appointments are ready for the job.

Featuring world class design and sophisticated, road proven refinements, Pearl Hardware is made to stand up to all the impact the gig can dish out, and backed by the industry's only Lifetime Warranty.



WL230A

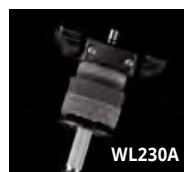

WL230A

WINGLOC
Quick Release Wing Nut (U.S. Patent #6884015)
Secure, adjustable, spring loaded cymbal nuts for quick set up and tear down.

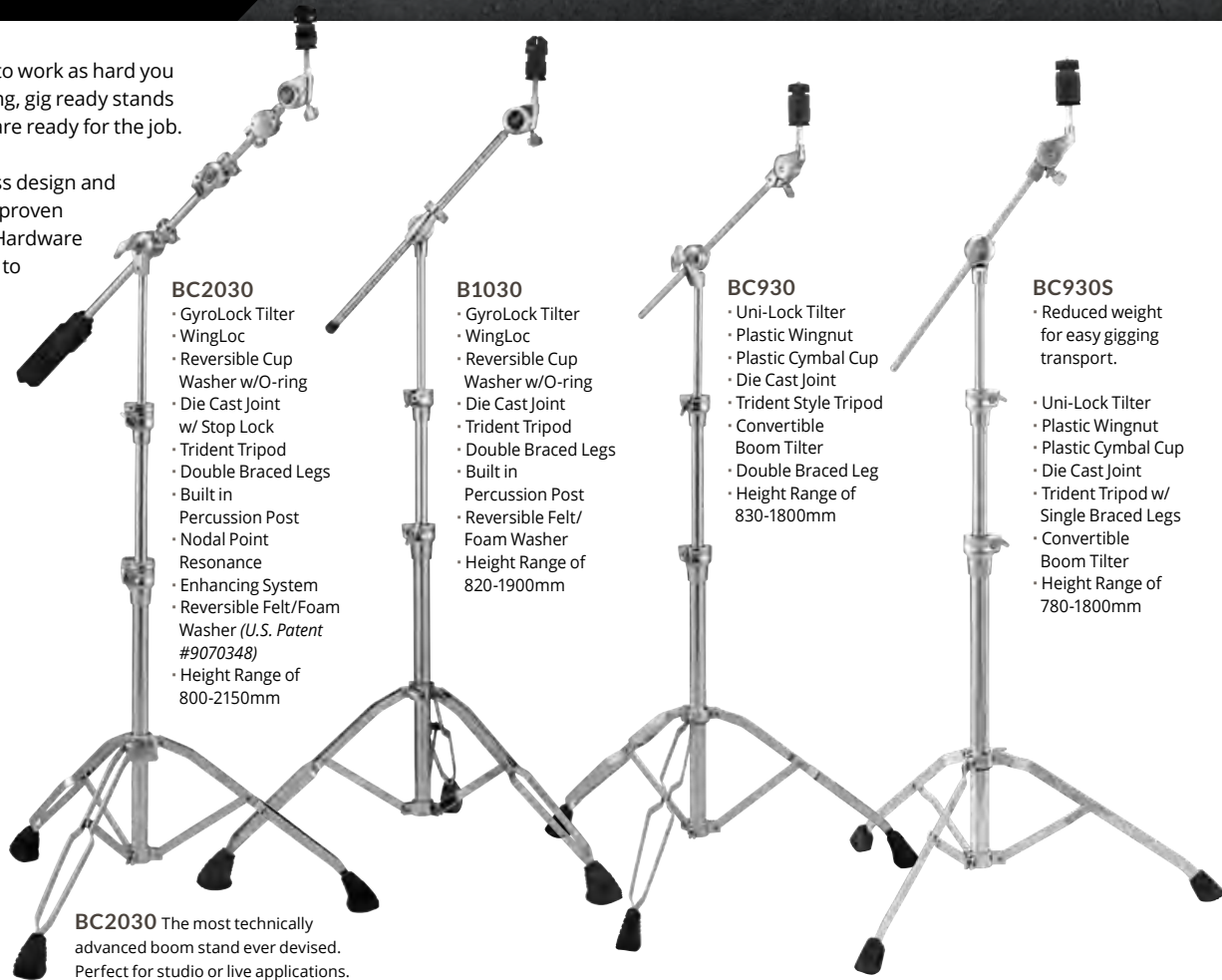

BC2030

- GyroLock Tilter
- WingLoc
- Reversible Cup Washer w/O-ring
- Die Cast Joint w/ Stop Lock
- Trident Tripod
- Double Braced Legs
- Built in Percussion Post
- Nodal Point Resonance
- Enhancing System
- Reversible Felt/Foam Washer (U.S. Patent #9070348)
- Height Range of 800-2150mm

BC2030 The most technically advanced boom stand ever devised. Perfect for studio or live applications.

B1030

- GyroLock Tilter
- WingLoc
- Reversible Cup Washer w/O-ring
- Die Cast Joint
- Trident Tripod
- Double Braced Legs
- Built in Percussion Post
- Reversible Felt/Foam Washer
- Height Range of 820-1900mm

BC930

- Uni-Lock Tilter
- Plastic Wingnut
- Plastic Cymbal Cup
- Die Cast Joint
- Trident Style Tripod
- Convertible Boom Tilter
- Double Braced Leg
- Height Range of 830-1800mm

BC930S

- Reduced weight for easy gigging transport.
- Uni-Lock Tilter
- Plastic Wingnut
- Plastic Cymbal Cup
- Die Cast Joint
- Trident Tripod w/ Single Braced Legs
- Convertible Boom Tilter
- Height Range of 780-1800mm



THE TRIDENT TRIPOD uses a full 360° of clamping force via the hinged collar. The inner tube rests in a nylon bushing to prevent metal to metal contact. Heavy duty legs feature lateral bracing for superior ultra quiet rigidity.



NODAL POINT MARKINGS
Pearl's BC2030 features patent pending markings on the telescopic tubes that allow cymbals to achieve better clarity and sustain when the tubes are positioned at their respective Nodal Points.



REVERSIBLE CUP WASHER w/ O-RING (U.S. Patent #6940006)
Specially designed to "float" normally or "lock" to prevent noise during recording.



GYROLOCK TILTERS are infinitely adjustable and provide 360 degree range of motion for precise positioning with one-step convenience.

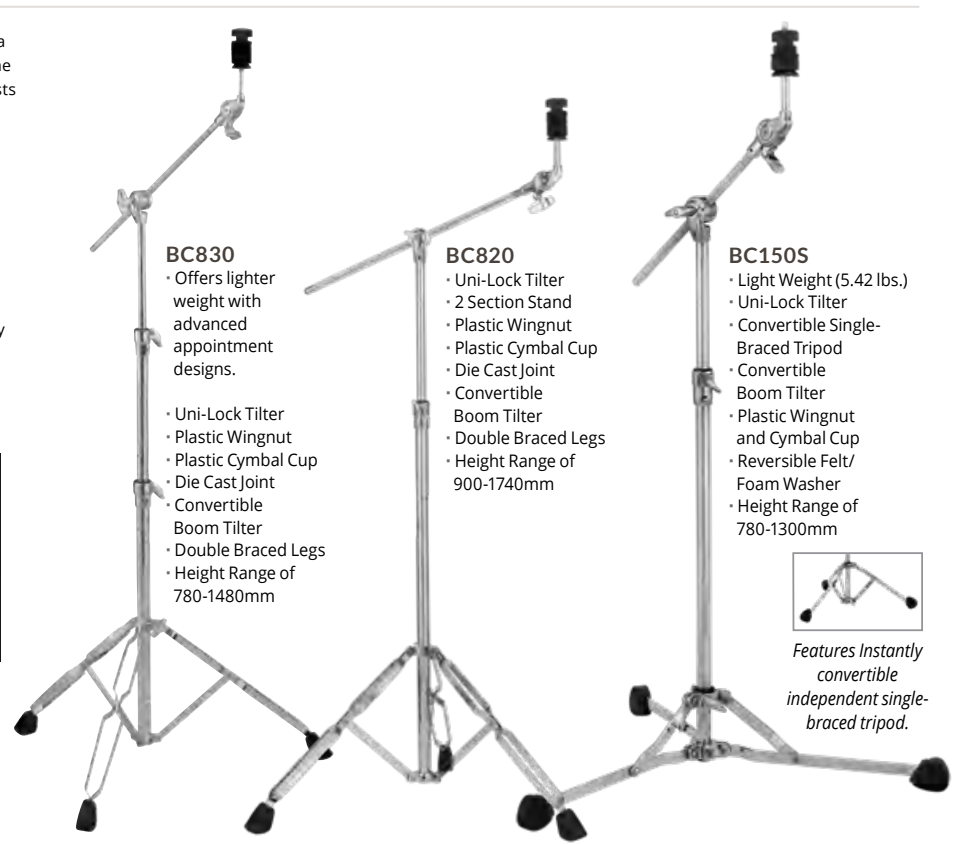

BC830

- Offers lighter weight with advanced appointment designs.
- Uni-Lock Tilter
- Plastic Wingnut
- Plastic Cymbal Cup
- Die Cast Joint
- Convertible Boom Tilter
- Double Braced Legs
- Height Range of 780-1480mm

BC820

- Uni-Lock Tilter
- 2 Section Stand
- Plastic Wingnut
- Plastic Cymbal Cup
- Die Cast Joint
- Convertible Boom Tilter
- Double Braced Legs
- Height Range of 900-1740mm

BC150S

- Light Weight (5.42 lbs.)
- Uni-Lock Tilter
- Convertible Single-Braced Tripod
- Convertible Boom Tilter
- Plastic Wingnut and Cymbal Cup
- Reversible Felt/Foam Washer
- Height Range of 780-1300mm



Features Instantly convertible independent single-braced tripod.

FOR EVERY CYMBAL, THERE IS A PLACE.

Advancing Drum Hardware for Serious Working Drummers since 1946.

Through constant setup, teardown, performance, practice, and transport, Pearl has you covered with cymbal stand solutions that are ready to endure constant abuse and keep going.

You're serious about drumming; get serious about your hardware.



"Pearl hardware is literally the only hardware that you'll ever have to buy and it's all backed by their incredible lifetime warranty!"
- TRACY BROUSSARD

TRACY BROUSSARD
BLAKE SHELTON

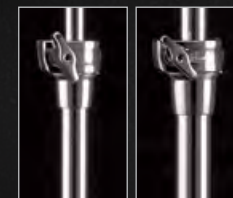

CLAMSHELL designed Die Cast joint on 2030, 1030, 930 series Boom and Straight cymbal stands, provides superhuman clamping force. Set your position, lock it down and wall away.



REVERSIBLE FELT / FOAM CYMBAL WASHERS allow four-way control of cymbal "ring" by mixing and matching the "hard" and "soft" surfaces of the washers.

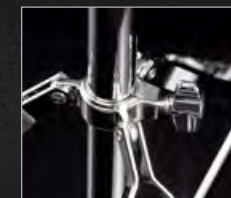

830 SERIES STANDS offer lighter weight while incorporating many of the 1030 series designs. The tripod uses Trident style design with double braced legs. Large easy to use wingnuts and lateral struts for optimal stability.

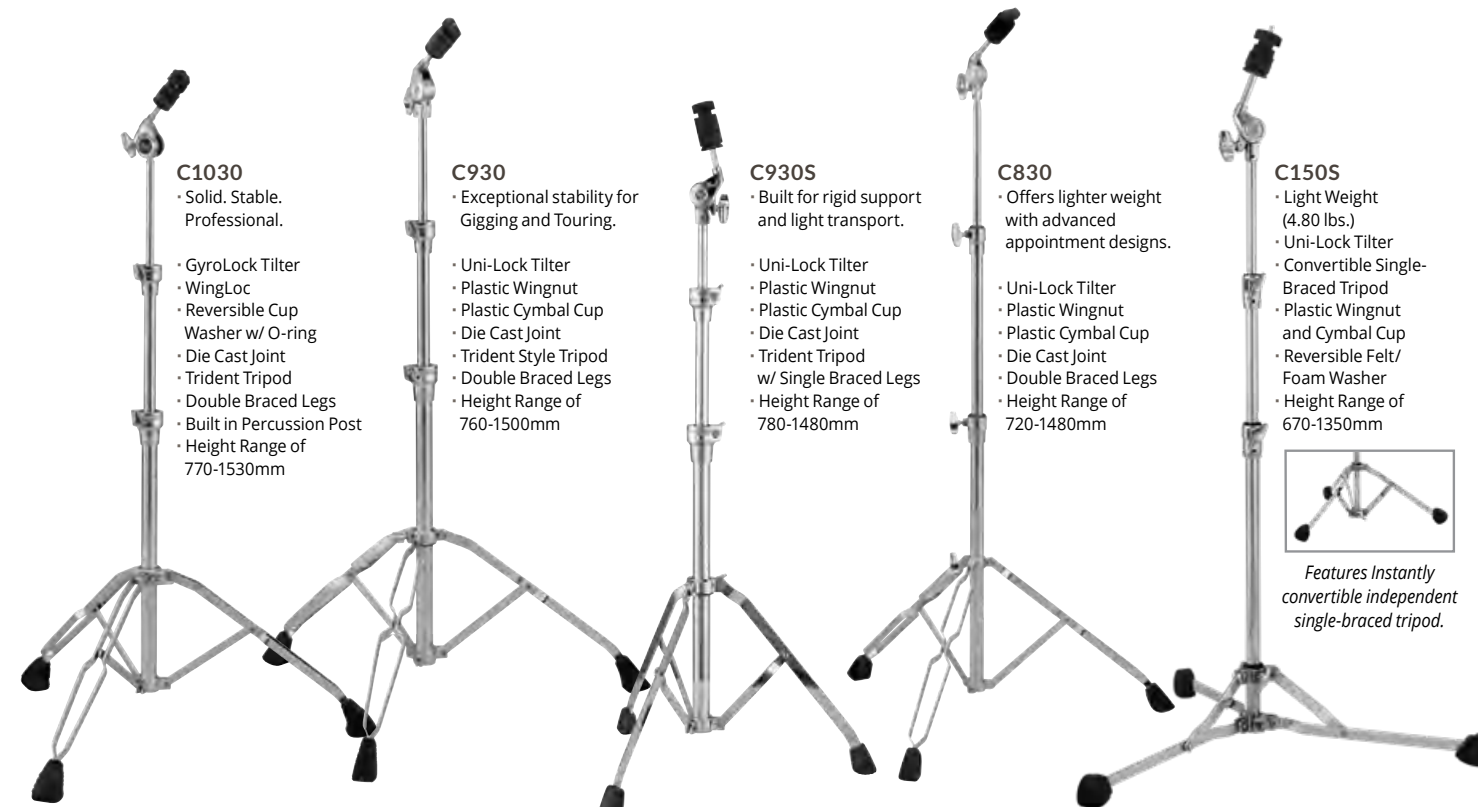

C1030

- Solid. Stable. Professional.
- GyroLock Tilter
- WingLoc
- Reversible Cup Washer w/ O-ring
- Die Cast Joint
- Trident Tripod
- Double Braced Legs
- Built in Percussion Post
- Height Range of 770-1530mm

C930

- Exceptional stability for Gigging and Touring.
- Uni-Lock Tilter
- Plastic Wingnut
- Plastic Cymbal Cup
- Die Cast Joint
- Trident Style Tripod
- Double Braced Legs
- Height Range of 760-1500mm

C930S

- Built for rigid support and light transport.
- Uni-Lock Tilter
- Plastic Wingnut
- Plastic Cymbal Cup
- Die Cast Joint
- Trident Tripod w/ Single Braced Legs
- Height Range of 780-1480mm

C830

- Offers lighter weight with advanced appointment designs.
- Uni-Lock Tilter
- Plastic Wingnut
- Plastic Cymbal Cup
- Die Cast Joint
- Double Braced Legs
- Height Range of 720-1480mm

C150S

- Light Weight (4.80 lbs.)
- Uni-Lock Tilter
- Convertible Single-Braced Tripod
- Plastic Wingnut and Cymbal Cup
- Reversible Felt/Foam Washer
- Height Range of 670-1350mm



Features Instantly convertible independent single-braced tripod.



3-Sided Rack
(*also available DR008 Expansion Bar)
DR80



Drum Rack Moveable
Support T-Leg
DR110T



Single Drum Rack, Straight
(w/ PCX100X2 & PCL100X2)
DR511



Straight Drum Rack Expansion Bar
w/ Support Leg
DR511E



Three-Sided Drum Rack, Straight
(w/ PCX100X4 & PCL100X2)
DR513



Single Drum Rack, Curved
(w/ PCX100X2 & PCL100X2)
DR511C



Curved Drum Rack Expansion Bar
w/ Support Leg
DR511CE



Three-Sided Drum Rack, Curved
(w/ PCX100X4 & PCL100X2)
DR513C

Developed in 1983 with legendary Toto drummer Jeff Porcaro, Pearl's original DR1 Drum Rack was the first freestanding, frame based drum support system available.

Now, Pearl expands the ICON (short for Independent CONTROL) Rack system with a fresh selection of upgrades and high function mounting options.



MASTERWORKS CUSTOM KIT
in Satin White Lacquer with Piano Black Stripes, Black Chrome Hardware



DMP927SP/C #229 WHITE SATIN PEARL
with 20" Gong Drum on two ICON straight racks



REFERENCE PURE #102 NATURAL MAPLE
To find out about this and other ICON RACK RECIPES, go to www.pearlrackrecipes.com



STS925XSP/C #766 BLACK MIRROR CHROME
with Added 8" x 7" Tom (STS0807T/C) And KMI Bop Pad

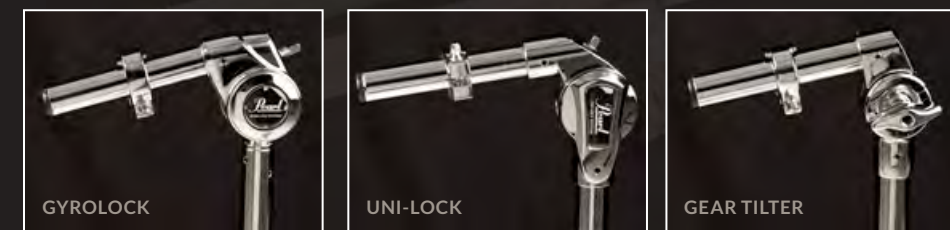

Our T/TC1030 Series features our GyroLock tilter for an infinite 360 degree range of movement. The T/TC930 Series use our Uni-Lock tilter for 180 degrees of motion. Our TH88 and TH70 Tom Arms Series use our dependable gear tilter.

ICON RACK RECIPES

Check out Pearl's ICON Rack Recipe videos at www.pearlrackrecipes.com for step-by-step instructions on how to get the most from existing and available Pearl Rack parts.

MOUNTING CLAMPS

Developed for the slip resistant ICON square rack rail and round support pipe. Each dramatically increases the level of setup flexibility and function variety.



Expandable Pipe Clamp
Fits All Icon Rack Leg Posts
PCL100

Dual Pipe Clamp
PCR100

Pipe To Rail Clamp
PCR200



Pipe To Rail Clamp
PCR200L



Rotating Pipe Accessory Clamp
PCR50X



Pipe Accessory Clamp
PCR50L

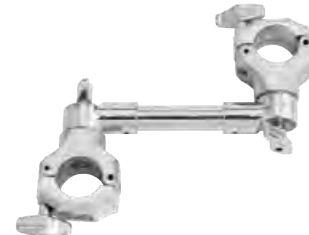

Rotating Dual Pipe Clamp
PCR50R



Curved Rack Rail
Short w/ Clamp
AL86AC

Curved Rack Rail
Medium w/ End Caps
AL103A

Icon Support Foot
w/ TLJ200 T-Clamp
P38475TA



Rail Accessory Clamp
Clamp System
w/ Adjustable Jaw
PCX100

Rotating Rail Accessory Clamp
Tilting Clamp System
w/ Adjustable Jaw
PCX200

Extended Rotating
Rail Accessory Clamp
PCX300

Pipe Clamp
Fits 7/8" tubes, for DR80
PC8

Icon
6" Mini-Expansion Bar
RJ50

Pipe Joint
RJ100



2 Clamps
Fits 5/8" to 1-1/8"
ADP20*

2 Revolving Clamps
Fits 1/2" to 1-1/8"
AX25*

2 Revolving Clamps
Fits 1/2" to 1-1/8"
AX25L*

In-Line & Revolving Clamps
Fits 5/8" to 1-1/8" & 1/2" to 1-1/8"
AX28*

3 Adjustable Clamps
Fits 3/8" to 1-1/4"
ADP30*

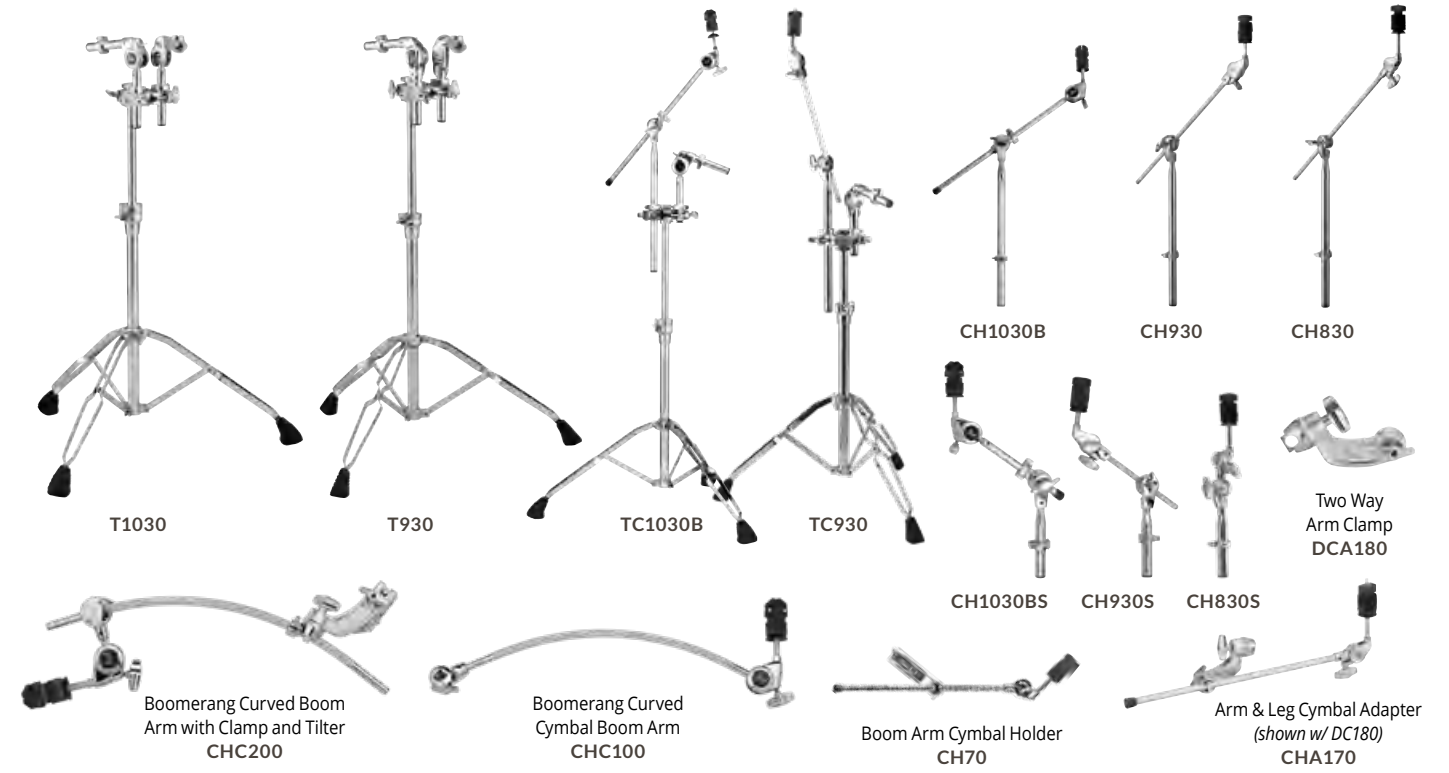

T1030

T930

TC1030B

TC930

CH1030B

CH930

CH830

Two Way
Arm Clamp
DCA180

Boomerang Curved Boom
Arm with Clamp and Tilter
CHC200

Boomerang Curved
Cymbal Boom Arm
CHC100

Boom Arm Cymbal Holder
CH70

Arm & Leg Cymbal Adapter
(shown w/ DC180)
CHA170

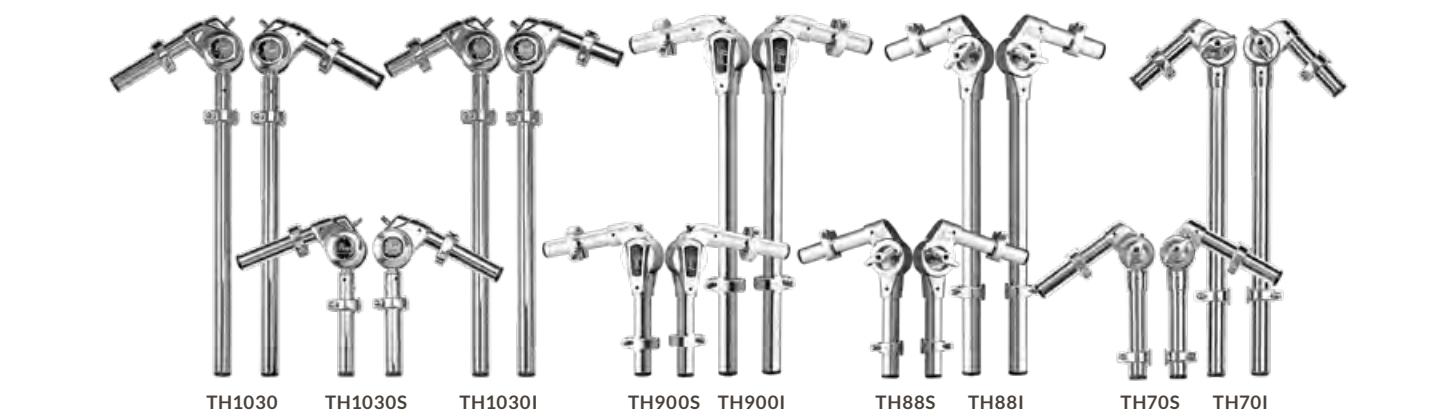

TH1030

TH1030S

TH1030I

TH900S

TH900I

TH88S

TH88I

TH70S

TH70I

UX80 & UX80S Universal Clamps feature rotating infinitely adjustable clamps for multiple uses. The TX100 accepts 7/8" dia. tubes making it ideal for extending the height of snare stands.



UX80S UX80

Height
Extender 13" Tube
TX100



Chrome Multi Bass Drum Legs
PMBDL3/C

Multi-Bass Drum Legs allow any bass drum to be played horizontally. Height and tilt adjustable.

Bass Drum Mount Cymbal Holder
CHB830

Mounts directly to the bass drum.



BOBBY ALLENDE
FIBERGLASS CONGAS AND BONGOS

Bobby demands the best, so he designed his Signature Congas and Bongos to exceed all existing standards, right down to the smallest details. For example, the seams are invisible thus giving his Fiberglass congas the look of wood. The beauty of these drums is more than skin deep, the thick fiberglass shells produce a rich tone and projection sure to get you noticed. The congas stand 28" tall to fit the traditional seated player and the wider base adds even more projection and stability. The superior rim design of the polished Contour Crowns on both the congas and bongos adds significant comfort for the player while complimenting the Remo heads. The drums feature a new super high gloss lacquer in #617 Confetti, personally designed by Bobby.



#617 Confetti
Signature Fiberglass Congas and Bongos

- CONGAS**
PCF110DXBA617 11" QUINTO
PCF117DXBA617 11.75" CONGA
PCF125DXBA617 12.5" TUMBA

- BONGOS**
PBF300DXBA617 7" & 8.5"



JESUS DIAZ
SIGNATURE OAK CONGAS AND BONGOS

Cuban born Jesus Diaz is one of the most in demand percussionists and vocalists on the scene today. His active schedule provided the feature set for his signature series of congas and bongos. Designed for the seated player the Thai Oak drums measure 30" tall and from the Quinto to Tumba feature added girth to the belly of the drum. Seated conga players typically have to tilt the drum to achieve the desired projection, but the Jesus Diaz drums feature a 4" port on the front of the drum that is strategically positioned to deliver the maximum base frequency while the drum remains flat on the floor. The drums also feature a newly designed Quick Release lug that is slotted to allow removal of the tension rod without fully removing the nut.



#580 Brushed Platinum
Natural Buffalo Skin Heads

- CONGAS**
PCW110DXPJD580 11" QUINTO
PCW117DXPJD580 11.75" CONGA
PCW125DXPJD580 12.5" TUMBA

- BONGOS**
PBW300DXJD580 7" & 8.5"

A new ergonomically friendly design reduces the impact to your hands while an internal ring centers the head for accurate placement.



Where can you take the Pearl Travel Congas and Bongos? The answer is anywhere you can take traditional drums but without any of the hassle. The Travel Congas feature a 3.5" deep wood shell with stave construction and Remo Symmetry heads. Available in three sizes: 11" x 3.5", 11.75" x 3.5" and 12.5" x 3.5" each with five precision Allen bolts. The 7" and 8.5" Travel Bongos feature 3.5" Thai Oak shells with Remo Fiberskyn heads and three point tuning. The Travel Congas and Bongos include a foam-handle tuning wrench.



Travel Conga Bag
PSC1175C

Travel Bongos Bag
PSC785TB

- 11.75" Travel Conga
#510 Caramel Brown
PTC1175N
- 12.5" Travel Conga
#510 Caramel Brown
PTC125N

- 11" Travel Conga
#510 Caramel Brown
PTC1100N

The optional Travel Conga Stand works with all three size drums and features a tension lever mounting system that locks the drum into place. The wide based, double braced legs provide a solid foundation for your drum and prevents the stand from moving during performance.

- Travel Bongos
#510 Caramel Brown
PTB785

- Travel Conga Stand
w/ Carrying Bag
PC800TC

- Travel Bongos Stand
PC800TB
PC800TBS (Short)

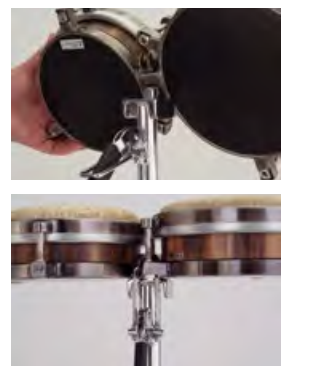

PEARL PERCUSSION ARTISTS

 AARON DRAPER JOHN MAYER / ADELE / EMINEM	 ALAIN PEREZ ALAIN PEREZ	 ANDY FARAG UMPHREYS MCGEE	 ARCHIE PENA SHAKIRA	 BRETT BAKER EMINEM / RIHANNA	 CAMILO QUINONES CQTHEDRUMMER	 CARLITO SOTO WILLIE COLON	 CESAR ESPINOZA ORCHESTRA TOBACO Y RON
 COLIN DOUGLAS AEROSMITH	 CHRISTIAN PEPIN INDEPENDENT	 DIMAS SANCHEZ RICO MONACO, IBA ASE	 DOMINIQUE THOMAS JOHN LEGEND	 EMRAH KOTAN INDEPENDENT	 ETTIENNE FUENTES INDEPENDENT	 FRANK KNUCKLES INDEPENDENT	 JESSIE CARABALLO MARC ANTHONY

PEARL PERCUSSION ARTISTS

 JOSE ROSA INDEPENDENT	 LALO DAVILA MTSU	 MARCO "ITO" ARGUINZONI INDEPENDENT	 MARVIN DIZ INDEPENDENT	 OG SLIGHTLY STOOPID	 OMAR LEDEZMA INDEPENDENT	 PAPO PEPIN CONGA LEGEND	 RAFA PEREIRA JANELLE MONAE
 RAVI JAKHOTIA RAVI DRUMS	 ROBERTO VIZCAINO JR AKOKAN	 ROLANDO MORALES MATOS THE LION KING	 SAMMY FIGUEROA INDEPENDENT	 SAMMY GARCIA INDEPENDENT	 TRILOK GURTU INDEPENDENT	 VALLERIE DEE NARANJO SATURDAY NIGHT LIVE BAND	 ZIG WALJER HAND ON WITH ZIG

Pearl has congas to meet the needs of every player from seasoned professionals to beginners. Our Elite Series offers the highest quality heads with polished Contour Crown rims and a choice of shell materials: 100% Thai Oak, seamless Fiberglass or a blended Oak/Fiber shell that offers the warmth of a wood shell with the added projection of Fiberglass. The Havana Series offers a wide belly design with Fiberglass shells that deliver a rich full tone. Our Primero Pro Series features professional-quality construction at an affordable price and a choice of 100% Thai Oak or Fiberglass. The Primero line

is ideal for students, band programs and beginners and features outstanding Pearl quality along with the same choice of 100% Thai Oak and Fiberglass. The Field Percussion Series features Fiberglass shells and heads that were designed for outdoor use by band programs. From the touring professional to the beginning student, Pearl has a series of congas to meet your needs.

Our bongos offer professional features and authentic styling in a choice of shell materials to perfectly match your conga set.

ELITE SERIES



ELITE WOOD-FIBER CONGAS
 PWFC110DX648 11" QUINTO
 PWFC117DX648 11.75" CONGA
 PWFC125DX648 12.5" TUMBA
 #648 Dark Chocolate

ELITE WOOD-FIBER BONGOS
 PWF100DX648 7" & 8.5"
 #648 Dark Chocolate



ELITE OAK CONGAS
 PCW110DX504 11" QUINTO
 PCW117DX504 11.75" CONGA
 PCW125DX504 12.5" TUMBA
 #504 Mocha Burst

ELITE OAK BONGOS
 PBW300DX504 7" & 9"
 #504 Mocha Burst



ELITE OAK CONGAS
 PCW110DX510 11" QUINTO
 PCW117DX510 11.75" CONGA
 PCW125DX510 12.5" TUMBA
 #510 Caramel Brown

ELITE OAK BONGOS
 PBW300DX510 7" & 9"
 #510 Caramel Brown

HAVANA SERIES



The stunning #644 Liquid Gold finish and chrome plated hardware completes a set of drums you can love forever.

HAVANA CONGAS
 PCF110HV644 11" Havana Quinto
 PCF117HV644 11.75" Havana Conga
 PCF125HV644 12.5" Havana Tumba

HAVANA BONGOS
 PBF300HV644 7" & 8.5"
 #644 Liquid Gold or
 #651 Red Tiger Stripe

The wide belly shape of these high end, fiberglass drums produce deeper low tones and greater volume. Contour Crown rims and natural skin heads give you clear highs and cutting slaps.



The exotic #651 Red Tiger Stripe finish is accentuated with gold plated hardware for a look that is as bold as the sound of the Havana Series.



ELITE FIBERGLASS CONGAS
 PCF110DXA 11" QUINTO
 PCF117DXA 11.75" CONGA
 PCF125DXA 12.5" TUMBA
 #641 Blue Sparkle Burst

ELITE FIBERGLASS BONGOS
 PBF300DXA 7" & 9"
 #641 Blue Sparkle Burst



ELITE OAK CONGAS
 PCW110DX506 11" Quinto
 PCW117DX506 11.75" Conga
 PCW125DX506 12.5" Tumba
 #506 Merlot Burst

ELITE OAK BONGOS
 PBW300DX506 7" & 9"
 #506 Merlot Burst



ELITE OAK BONGOS
 PBW300DXG 7" & 9"
 #535 Satin Black w/ Gold Hardware

ELITE OAK CONGAS
 PCW110DXG 11" QUINTO
 PCW117DXG 11.75" CONGA
 PCW125DXG 12.5" TUMBA
 #535 Satin Black w/ Gold Hardware

Also available in #532 Cherry Eucalyptus

CONGA RESO-PLATE

Designed for the seated conga player, Pearl's Reso-Plate will give you that hard surface desired for maximum resonance. Configured with a cutout handle, the plates can also easily be placed on top of your drums for extra protection when packed in your conga case.



Conga Reso-Plates
 PRP140

PRIMERO PRO

PRIMERO PRO FIBERGLASS

Primero Pro Fiberglass congas and bongos are available in: #621 Wine Red Marble, #626 Gold Marble, and #628 Blue Marble



11.75" & 12.5" Conga Set #628 Blue Marble
 Shown with matching bongos
 PFC302DX628



12" Conga #621 Wine Red Marble
 PFC120DX621



10" & 11" Conga Set #621 Wine Red Marble
 PFC202DX621

PRIMERO PRO OAK

Primero Pro Oak congas and bongos are available in: #511 Natural, #521 Midnight Fade, and #523 Carbon Vapor



7" & 8.5" Bongos #523 Carbon Vapor
 PWB100DX523

11.75" & 12.5" Congas #523 Carbon Vapor
 PWC302DX523

PRIMERO

PRIMERO OAK CONGA SETS

Primero Oak congas and bongos are available in: #511 Natural

*Shown on PC300W Double Conga Stand, PB700BHS Bongo Attachment sold separately



10" & 11" Conga Set* #511 Natural
 PWC202511

PRIMERO FIBERGLASS CONGA SETS

Primero Fiberglass congas are available in: #602 Bistre Black #631 Ebony



6" & 7" Bongos #511 Natural
 PWB67511

10" & 11" Conga Set #602 Bistre Black
 PFC204602

Shown on PC100P and PC110P Basket Stands

FIELD PERCUSSION SERIES



10" & 11" Congas #649 Textured Black
 PFC202EDU649

PFC302DX626 #626 Gold Marble



Pearl's ever-popular Primero Pro congas and bongos are designed with professional features at an affordable price. Our expanded range of sizes offers 10" & 11" and 11.75" & 12.5" sets in both Thai Oak and Fiberglass with matching bongos.

PFC202631 #631 Ebony



Primero Series congas and bongos are available with wood or fiberglass shells and in packages that include a double stand, single basket stands or without stands.

Cajons are the perfect introduction to the world of percussion. Affordable, easy to carry and just plain fun to play. Pearl offers a diverse collection of Cajons with a complete selection of accessories to customize your instrument and develop your own unique sound. Perfect for drum circles, small gigs or even studio work, your Cajon will become your new best friend.

*Available exclusively in the USA

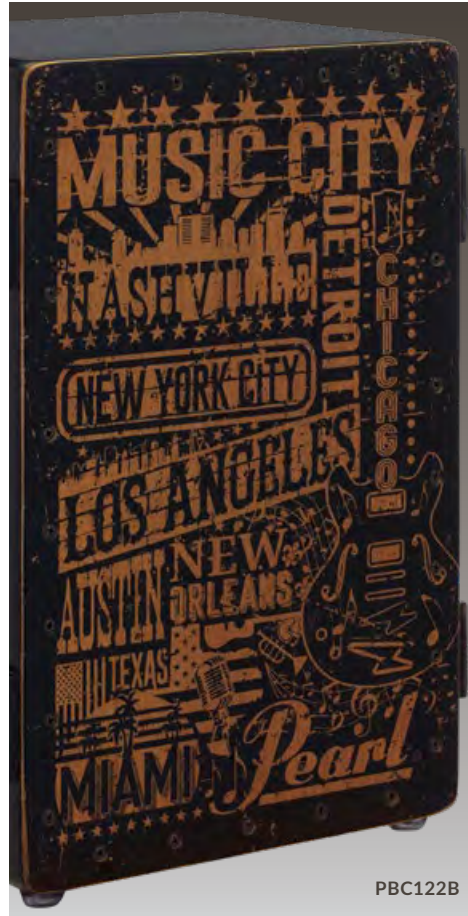

PBC122B



PBC123BTR



PBC123BBR



PRIMERO BOX CAJON PBC122B

The body of this cajon is constructed using MDF and features a Meranti faceplate. The built-in bass port magnifies the massive low-end tone while two sets of fixed snare wires provide a bright, crisp snare response.

Music Town USA

19.25" T x 11.75" W x 11.75" D



PRIMERO BOX CAJON PBC123BTR

This cajon is constructed using MDF and features a Meranti faceplate with a built-in bass port and two sets of fixed snare wires. The finish features a hand painted and silkscreened design that wraps around three sides and depicts the Tree of Life.

Tree of Life

19.25" T x 11.75" W x 11.75" D



PRIMERO BOX CAJON PBC123BBR

The Raven cajon is constructed with MDF and has a Meranti faceplate and built-in bass port and two sets of fixed snare wires. The finish is a hand painted and silkscreened design that wraps around 3 sides featuring a stylized black raven.

The Raven

19.25" T x 11.75" W x 11.75" D



PRIMERO BOX CAJON PBC120B

The body of this Primero cajon is constructed using MDF and features a Meranti faceplate. A built in bass port magnifies the massive low-end tone of the cajon while two sets of fixed snare wires provide a bright, crisp snare response.

Abstract Red

19.25" T x 11.75" W x 11.75" D



PRIMERO BOX CAJON PBC121B

This Primero cajon features a figured Cherry faceplate that delivers enhanced bottom-end tone that is magnified by the built in bass port. Two sets of fixed snare wires provide a bright, crisp snare response.

Figured Cherry

19.25" T x 11.75" W x 11.75" D



18.75" T x 14" W x 16" D

SONIC BOOM FLAME THROWER CAJON*

PBC1914FT
Made In The USA. Features a Flame Maple faceplate that adds a new voice to the Sonic Boom family. Two strategically placed bass ports are located at the top on the back to increase snare projection. Fiery Red and Natural Finish.



18.5" T x 14" W x 16" D

SONIC BOOM*

PBC1914SB
Made in the USA. Massive low-end producer perfect for small acoustic settings or larger amplified venues. 100% Birch construction provides exceptional resonance that speaks clearly through the frontward facing bass port. This Box Rocks!



18.5" T x 14" W x 16" D

SONIC BOOM BUZZ*

PBC1914SBS
Sister to the popular Sonic Boom, the Buzz adds fixed snares and a resonant Artisan Walnut front plate. This beautiful cajon really has the deep bass and punchy snare crack you need to emulate a drum set.



19" T x 14" W x 16" D

MACH 3 CAJON*

PBC1914M3
Made in the USA. The Mach 3 features a 100% Birch body with three isolated playing zones that simulate snare, bass and tom sounds. The backwards tilted front plate provides a comfortable playing position.

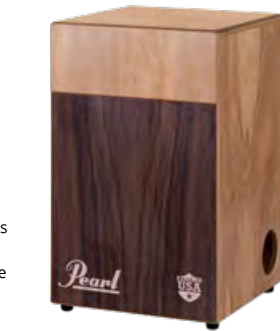

19.5" T x 12" W x 12" D

MACH 2 CAJON*

PBC511M2
Made In The USA. The Birch snare section of the faceplate creates a bright response while the Walnut bass section provides a punchy low end. An internal resonance plate prevents unwanted crosstalk between the sound chambers.

#511 Natural Finish



19.5" T x 12" W x 12" D

AFTERBURNER CAJON*

PBC511ABC
Made in the USA. The Afterburner cajon features dual rear-firing ports that resemble the exhaust on a classic hot rod and delivers the same low end rumble. The 100% Birch body has a premium grain natural finish.

Dual Rear-Firing Ports



18.75" T x 12.5" W x 12.5" D

JINGLE CAJON

PCJ629616
The Pearl Jingle Cajon features 2 sets of adjustable platina and tambourine jingles on the faceplate and the cajon can be played with the jingles turned on or off and anywhere in between. The jingle Cajon features a fiberglass body and hardwood faceplate with three sets of fixed snares.

#616 Artisan Wood Grain

CAJON ACCESSORIES

Enhance your performance by adding new, dynamic sounds.



Cajon Holster Nylon w/ Velcro Straps
CAJH100



Wood Block w/ 3M Dual-Lock Tape & Mounting Bracket (PPS37 Not Included)
PBCW100

Jingle Cup Two Pack
Suction Cups attach to the cajon face, acoustic guitars, or other drums.
PJCP1/6



Clave Block w/ 3M Dual-Lock Tape & Mounting Bracket (PPS37 Not Included). Play handheld or stand mounted.
PBC100



3 Way Cajon Riser
First Lift = 21", Second Lift = 23", Third Lift = Angled Option
PBCR1535



18.75" T x 12.5" W x 12.5" D

BOOM BOX CAJON

PCJ633BB635
The Pearl Boom Box Cajon features a fiberglass body and built in bass port that magnifies the subsonic frequencies. Three sets of fixed snare wires add a crisp response to the wood faceplate.

#635 Artisan Zebra Wood

TIMBALES

BUILD THE RIGHT RIG FOR THE GIG!

MARC QUIÑONES
DOOBIE BROTHERS



MARC QUIÑONES
SIGNATURE TIMBALES



Marc Quiñones
Signature Timbales
14"x7" / 15"x7" Steel
w/ Tilting Stand and
PBL30 Clave Block
(Cowbell Not Included)
ETE1415MQ

BANDA SERIES



Banda Timbales
15"x10" / 16"x10" Steel
w/ Tilting Stand
PBTM1516/C



Banda Tambora
24"x18" Bass w/ Cymbal Mount, Stand & Mallet
PBTB2418/C33



Primero
13"x7" Steel Timbale
w/ PPS36 Mount
PTE1336



FLAT TIMBALE w/ I.S.S.
13"x3" Steel
PTE3131



Flat Timbale w/ I.S.S.
13"x3" Brass
PTB3131



Primero Timbales
13"x6.5" / 14"x6.5" Steel
w/ Tilting Stand
(Stands & Cowbell Included)
PTS5134



Primero Pro Timbales
14"x7" / 15"x7" Steel
w/ Tilting Stand
(Sticks Included. Cowbell Not Included.)
PTE1415DX



Tilting Timbale Stand (Short)
Height Range 26.5" to 36.5"
PT900WS

COWBELLS

HORACIO HERNANDEZ INDEPENDENT



Pearl and Grammy Award winning artist Horacio Hernandez have developed the ultimate family of cowbells. The HH4XH bell features a quick release system that allows the bell to lift easily off of its mount for hand held playing.

HORACIO HERNANDEZ
SIGNATURE COWBELLS



Marybell HH5 Hand-Held Campana Quick Release HH4XH Isabell Mambo Bell HH4 Chabella HH3 Clabell HH2 Bella HH1

BALA BELLS



Mounted Campana Bell BCM10 Hand-Held Campana Bell BCH10

AGOGO & TRIBELLS



Tri-Bells PTB30 Hand-Held Agogo ECB22 Mounted Agogo ECB23 Tri Agogo PTA30 Pro Cowbell Beater PDC60

NEW YORKER BELLS



Cha-Cha (High) BCM3NY Cha-Cha (Low) BCM5NY Mambo BCM7NY Marc Quiñones Sig. Timbale Bell BCM8NYQ

PRIMERO COWBELLS



Guiro Cowbell 8" Bell PCB10GR 10" Millennium Chrome Bell PCB10MCR 10" Bell w/ PPS30 PCB1030 6" Bell PCB6 4" Bell PCB4

RAINSTICKS



BAMBOO RAINSTICKS WITH BURNED FINISH #694 RHYTHM WATER

60" Bamboo Rainstick PBRSB60694

48" Bamboo Rainstick PBRSB48694

40" Bamboo Rainstick PBRSB40694

32" Bamboo Rainstick PBRSB32694

24" Bamboo Rainstick PBRSB24694

16" Bamboo Rainstick PBRSB16694

Pearl is expanding its line of shakers to include six Bamboo rainsticks ranging in size from 16" to 60" and available in two unique finishes.

Pearl's natural Bamboo Rainsticks are 2.5" in diameter and feature an internal spiral maze of tines that a cascade of lava pebbles flow over to create the soothing sound of falling rain.

16" Bamboo Rainstick PBRSP16693

24" Bamboo Rainstick PBRSP24693

32" Bamboo Rainstick PBRSP32693

40" Bamboo Rainstick PBRSP40693

48" Bamboo Rainstick PBRSP48693

60" Bamboo Rainstick PBRSP60693

BAMBOO RAINSTICKS WITH PAINTED FINISH #693 HIDDEN SPIRIT

COWBELLS

HORACIO HERNANDEZ INDEPENDENT



Pearl and Grammy Award winning artist Horacio Hernandez have developed the ultimate family of cowbells. The HH4XH bell features a quick release system that allows the bell to lift easily off of its mount for hand held playing.

HORACIO HERNANDEZ
SIGNATURE COWBELLS



Marybell HH5 Hand-Held Campana Quick Release HH4XH Isabell Mambo Bell HH4 Chabella HH3 Clabell HH2 Bella HH1

BALA BELLS



Mounted Campana Bell BCM10 Hand-Held Campana Bell BCH10

AGOGO & TRIBELLS



Tri-Bells PTB30 Hand-Held Agogo ECB22 Mounted Agogo ECB23 Tri Agogo PTA30 Pro Cowbell Beater PDC60

NEW YORKER BELLS



Cha-Cha (High) BCM3NY Cha-Cha (Low) BCM5NY Mambo BCM7NY Marc Quiñones Sig. Timbale Bell BCM8NYQ

PRIMERO COWBELLS



Guiro Cowbell 8" Bell PCB10GR 10" Millennium Chrome Bell PCB10MCR 10" Bell w/ PPS30 PCB1030 6" Bell PCB6 4" Bell PCB4

TONGUE DRUMS

AWAKENING SERIES
TONGUE DRUMS

Pearl proudly introduces the Awakening Series of 6 Tongue Drums: Three 8 note and three 9 note drums tuned to pentatonic scales.

Tongue drums derive their name from the tongue shaped areas where you strike the drum. The results are a cosmic blend of tones that are as much fun to hear as play.



8 Note G Major #687 Blue Burst PMTD8GMF687



8 Note A Ake Bono #688 Brown Burst PMTD8AKBF688



8 Note A Minor #689 Green Burst PMTD8AMF689



9 Note C Lydian #690 Orange Burst PMTD9LYDF690



9 Note C Major #691 Crimson Burst PMTD9CPTF691



9 Note C Ake Bono #692 Purple Burst PMTD9AKBF692

Each drum features a 10" hardened steel shell with precise laser cut tongues for accurate and consistent tuning. Pearl Tongue drums can be played with your fingers or with a set of mallets included with each drum.



Tongue Drum Bag PTDB10B

9 Note C Ake Bono #692 Purple Burst PMTD9AKBF692

DJEMBES

ANCIENT INSTRUMENTS FOR THE MODERN PERCUSSIONIST

DJEMBES Djembes are a traditional African instrument that offer a wide variety of sounds and are perfect for drum circles. The Professional Elite Series is available in Oak (12.5" diameter) and Fiberglass (12.5" and 14" diameter). All feature our Contour Crowns for comfortable playing and authentic Goat skin heads for deep lows and crisps highs.

#696 PURPLE HAZE
Top Tuned Djembes



#697 TRIBAL FIRE
Top Tuned Djembes

#698 ZEBRA GRASS
Rope Tuned Djembes



#699 MOLTEN SCARLET
Rope Tuned Djembes



Ez Tune Djembe 14" (Oak) #533 Gloss Black PJV140R533	Ez Tune Djembe 12.5" (Oak) #533 Gloss Black PJV125R533	Ez Tune Djembe 12" (Fiberglass) #632 Cranberry Fade PJF320RX632	Ez Tune Djembe 14" (Fiberglass) #632 Cranberry Fade PJF350RX632	Field Percussion Djembe 14" (Fiberglass) #649 Textured Black PJF350FP649	Elite Oak Djembe 12.5" #511 Natural PJV340	Elite Fiberglass Djembe #602 Bistre Black PJF350 14" PJF320 12.5"	Fiberglass Fun Drum PFD300
---	---	--	--	---	---	--	----------------------------------



12" Hand Carved Mahogany Djembe #695 Malinke Village PBJWR12695

Djembe Stand • Fits 8" to 14" Pearl Rope Tuned And Top Tuned Djembes PBJSTD

Djembass PJB5350

DJEMBASS If you want extreme low-end, and a head-turning alternative to a standard bass drum, look no further than to Pearl's Djembass. Convert our most popular PJF350 Fiberglass Djembe into a compact kick drum with the Djembass accessory pack. To reduce the attack and add greater "lows" we have included a cloth cap that stretches around the head. For greater low-end, slip the included neoprene disc inside which give you two sound options. Your pedal (not included) attaches via an I.S.S. type clamp to the Djembe's stand mounting plate.

FOLKLORIC

TRADITIONAL LOOK, MODERN INNOVATION



Tumbador 12.5" PCW125FC Qunito 11" PCW110FC Segundo 11.75" PCW117FC Folkloric Elite Bongos 7" & 8.5" PBW300FC

FOLKLORIC ELITE CONGAS
Pearl's line of Folkloric congas feature a traditional look with modern innovation that only Pearl can deliver. Each 28" tall Oak conga is designed for the "seated" player, but is predrilled for stand mounts if necessary. Thicker South American style natural skins makes the drums warm sounding, but a fiberglass gel coat on the interior seals the shell and adds the projection and volume desired by today's players. Four Polished Steel Reinforcing Bands are inset on the shell for a smooth touch, and the traditional hoops complete these stunning instruments in a Matte Crimson Sunrise finish. The 7 & 8.5" Oak Bongos have the same hardware and shell features of the congas. The thicker bongo skins add to the projection and "dry" tone reminiscent of that classic Cuban sound.

BATAS Pearl Percussion Bata drums are available in Crimson Sunrise, the same beautiful finish featured on our Folkloric Elite congas and bongos. Additionally, the hardware is finished in Polished Steel and matches the hardware on our other tunable hand drums. These sacred ceremonial instruments have a thicker Enu (large) head for a deep, rich tone.



Itotele PBA60 Oconcolo PBA50 Iya PBA70



Bamboo Clave PCL10FCB Wood Clave PCL20FCW Uno PSK50FC Segundo PSK60FC Caja PSK70FC

Cata w/ Holder PCA14FC Achere PAC10FC Guataca PGT10FC

BRAZILIAN



Timbao PBTB140 Tan Tan PBTA1420 Surdo 20" PBS2018 Surdo 18" (Shown with optional PBS30BD) PBS1822 Surdo 22" PBS2222

Legs & BD Adapter Kit For Surdo PBS30BD

Tamborim Stick PBT70S

Surdo Mallet PBSM20 Rocar PBRC80

BRAZILIAN PERCUSSION
Pearl's line of Brazilian Percussion brings modern refinements and Pearl quality to the traditional Samba musician. Our Repinique features lightweight yet sturdy steel shells with etched heads, shoulder straps and low rims for incredible playing comfort. The lightweight wood shell Surdos allow for hours of comfortable play when worn over the shoulder with the provided strap. Available in 18"x22", 20"x18" and 22"x22" sizes (diameter x depth), Pearl's popular Surdos continue to be the industry standard. The Timbao is made from lightweight fiberglass, and is capable of the extremely high tension utilized in tradition Brazilian ensembles. The Rocar is equipped with brass and steel platinellas, and can be played as a single shaker, or separated for two-handed sonic options.



Caixa 12" PBCX1204 Caixa 12" PBCX1265 Cuica PBC80SS

Repinique 10" w/ Strap PBR10S Repinique 12" w/ Strap PBR12S

Pandeiro 10" (5 Sets Platinellas & Goat Skin Head) w/ Bag PBP510 Pandanza w/ Agogo Bell PDZ510

Pandeiro 12" (6 Sets Platinellas & Plastic Head) w/ Bag PBP612 Tamborim w/ Quick Draw Mount PBT60C

CONCERT PERCUSSION

ENGINEERED FOR THE PROFESSIONAL PERCUSSIONIST

NOTE: Items pictured are not to scale

Pearl is proud to offer Concert Percussion instruments that are attractively priced for school ensembles, yet engineered with the professional percussionist in mind. The symphonic tambourine is a perfect example. Its 17 pairs of specially aged, stamped brass jingles provide a dry, yet bright tone that brings added color to any musical situation. Its 10" headed

wood frame allows the player to effortlessly perform all tambourine techniques, and the tambourine's plush carrying case is included. The rattler is another vital component to any concert percussionists' equipment, and Pearl's is built with an extended handle for a comfortable grip and ease of playing. Holders for the rattler and castanets are also available.



16" Ocean Drum
PFSM16



Elite Concert Tambourine
PETM20

Symphonic Tambourine
PETM1017

14" Frame Drum
PFR14C

Frame Drums Set of 6 • Sizes: 8", 10", 12", 14", 16", 18"
PFR0818C



ORCHESTRAL TAMBOURINES

The Pearl Orchestral Series Professional Tambourines provide performers a new voice and sound for any performing situation.

These 5 instruments feature uniquely sourced and hand-hammered jingles combinations of German Silver, Phosphor Bronze, Beryllium Copper, and Yellow Brass that give a full

spectrum of color and projection options to players. The 10" shell is a well-balanced and lightweight 2-ply Mahogany design with contoured hand-hold areas for comfortable performance and warm tone. The natural finish goatskin head provides a full responsive sound and traditional look without sacrificing durability. **Includes bag.**



Mix Copper And Brass
PETM1018CR

Mix Copper and Bronze
PETM1018CB

Mix German Silver and Copper
PETM1018GC

Beryllium Copper
PETM1018CP

German Silver
PETM1018GS

Castanets (Long Handle)
PCN20

Castanets
PCN20S

Castanets Holder
PCN20H

Slap Stick
PSS100

Elite Concert Wood Blocks
(High) (Medium) (Low)
PCWB100A PCWB200A PCWB300A



Stix-Free Triangle
Holder w/ 8" Triangle
PPS12T

10" Triangle
PET100

8" Triangle
PET80

6" Triangle
PET60

Triangle Clip
PTC10

Trio Triangle Holder
PTC300

Temple Blocks
PCWTB05

Rattler
PRT10

HAND PERCUSSION

A WORLD OF HAND PERCUSSION



Natural Gourd Guiro
PNG20

Metal Guiro
PMG20

Beaded Maracas
PFM20

Maracabasa
PFM50

Natural Hide Maracas
PRM20

Basket Ganza 9" X 4"
PGA20



Shakelets
PWR40

Spirit Chimes
w/ Holder and Mallet
PSC30BR

36 Anodized Aluminum Chimes
w/ Case, Holder, And Striker
PWCH3620A

32 Gold Anodized Aluminum Chimes
w/ Case, Holder, and Striker
PWCH3220G

Foldable 36 Anodized
Aluminum Chimes
PWCHF3620AF



9" Primero Rock Tambourine
w/ Millennium Jingles
PTM09BK

Headless Wood Tambourines
PTH10B (Brass) PTH10S (Steel)

Tambourine w/ Brass Jingles
PTM10GH

Steel Jingle Tambourine
w/ Stainless Steel Jingles
PTM10SH

Ultra Grip Volume Adjustable Tambourine
PTM50BHR (Brass)
PTM50SHR (Steel, not pictured)



Gatling Cabasa
CBS100

Tang-Tang
PTG20

(High)
PAB20

(Medium)
PAB50

(Low)
PAB100

(High)
PBL10

(Medium)
PBL20

(Low)
PBL30



21" Field
Percussion Shaker
PGA60FP

Wood Hex Ganzas
PGA30W (Short) PGA32W (Long)

Hex Ganzas
PGA30 (Short) PGA32 (Long)

Triple Shaker
PGA40

Groove Shaker
PGA50SF

Egg Carton
PEC1



CONGA STANDS



Pro Conga Stand PC3000
Quick Release Double Conga Stand w/ Bag PC3000TW
Ultra Lite Conga Stand PC2500



PERCUSSION STANDS & BRACKETS

The PC3000TW stand holds full size professional congas as securely as most stands double its weight and mass. The PC3000W is scaled down to support our lighter Primero Conga lineup. Both stands setup in seconds because there are no wingnuts needed to mount your congas. The PC2500 Ultralite Conga stand, is lightweight yet sturdy and stable. Index markings on all adjustable parts make for consistent lightning fast setups.

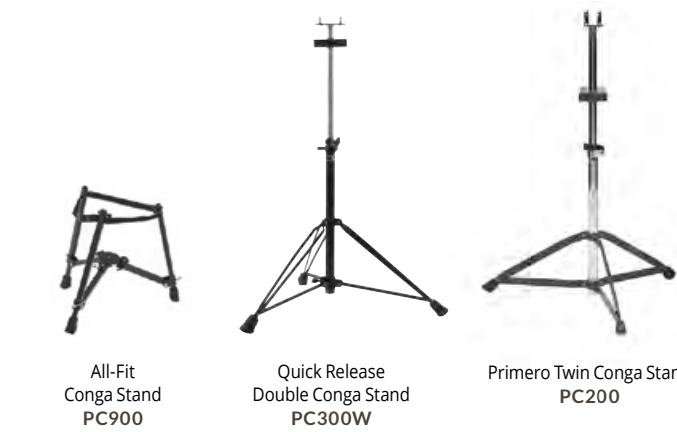

All-Fit Conga Stand PC900
Quick Release Double Conga Stand PC300W
Primero Twin Conga Stand PC200

BONGO STANDS



Pro All Fit Bongo Stand with Spring Loaded Strap Hinge PB3000
Bongo Stand for Seated and Concert Players PB3000S
All-Fit Tilting Bongo Stand PB900LW
Lightweight Bongo Stand PB700
Bongo Attachment for PC200 PB700BHS

DJEMBE STANDS

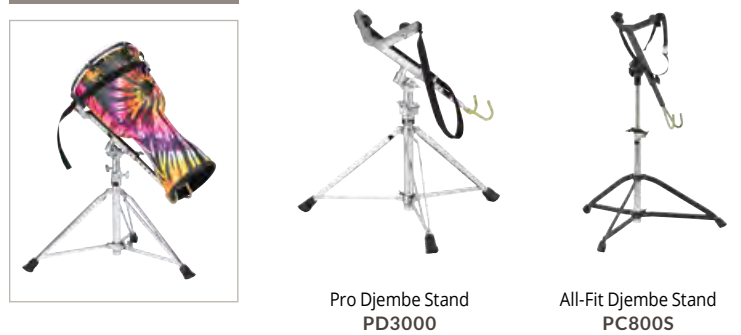

Pro Djembe Stand PD3000
All-Fit Djembe Stand PC800S

CAJON STANDS



Cajon Stand PCJ70STD

TRAP TABLE

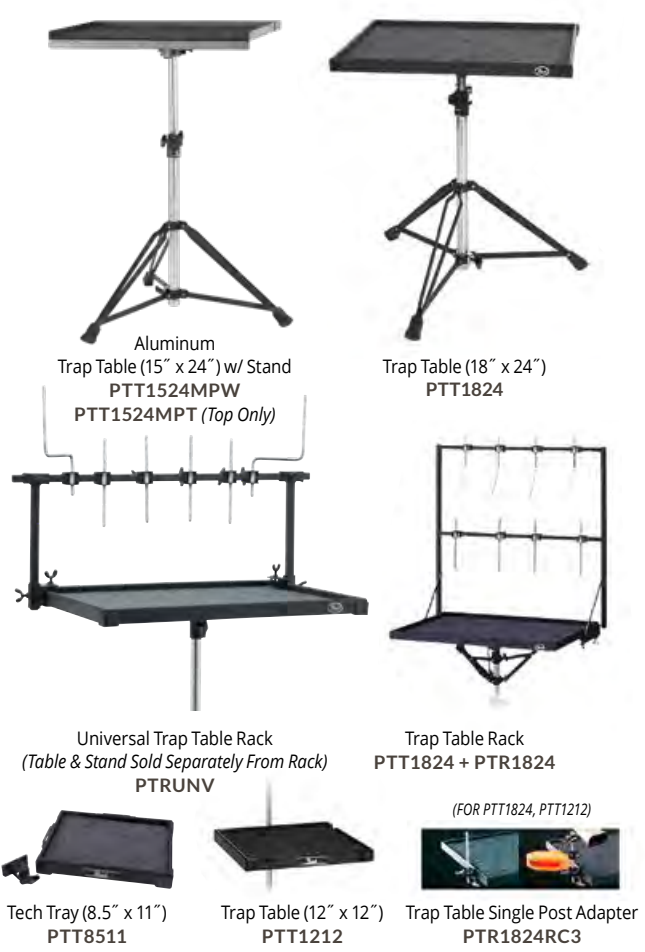

Aluminum Trap Table (15" x 24") w/ Stand PTT1524MPW
Trap Table (18" x 24") PTT1824
Universal Trap Table Rack (Table & Stand Sold Separately From Rack) PTRUNV
Trap Table Rack PTT1824 + PTR1824
Tech Tray (8.5" x 11") PTT8511
Trap Table (12" x 12") PTT1212
Trap Table Single Post Adapter PTR1824RC3

Our popular PTT1824 Trap Table can be easily converted into a two-level folding rack without drilling or modifications by simply adding the PTR1824 Add-On Rack. The PTR1824 installs in seconds using clamps and folds flush with the table for easy pack-up. A unique clamping system allows the included (4) straight and (4) angled 3/8" knurled posts to clamp anywhere onto horizontal or vertical areas of the rack. Also included is a retractable three-legged stabilizer bar for optimum stability. The easy-to-attach PTRUNV Universal Trap Table Rack mounts on virtually any trap table and features six 3/8" rods and receptors for various percussion mounting possibilities.

HOLDER & ACCESSORIES



Angled Post Adapter PPS37
Lug Mount Accessory Holder PPS40
Universal Guiro Holder PGH20
Foot Pedal Bracket PPS20
Cowbell Stacker PCS10
Stix-Free PPS10 & PPS11
Percussion Toy Box (Accessories Not Included) PTYB1212

COWBELL HOLDERS



CA130
75H
75X
PPS81
PPS82

PERCUSSION CASES

Features include: ergonomic carrying straps, rubber protective bottoms, top-mounted carrying handles, tuning wrench pouches, & heavy duty double zippers.



Fits Havana Series
Conga Bag - Quinto PSC110CGW
Conga Bag - Conga PSC117CGW
Conga Bag - Tumba PSC125CGW
12" Djembe Bag PBJCXL
14" Djembe Bag PBJCXXL
Box Cajon Case 13" x 14" x 20" PSC1213CJ
Travel Conga Case PSC1175TC
Bongo Bag PSCBB
12.5" Conga Bag PSC125CG
11.75" Conga Bag PSC117CG
11" Conga Bag PSC110CG
14" Djembe Bag PSC140DJ
12.5" Djembe Bag PSC125DJ

MASKING COVERS & MOUNTING BRACKET



- BBC1** for BB3, w/Gasket, Screws and Nuts
- GK90** for BT3, inside/outside plates w/Bolts
- BT3** Tom Tom Bracket

BASS DRUM HOOP PROTECTORS



- HPP2** Metal Hoop Protector for Wood BD Hoops
- NP01** Hoop Protector for Metal BD Hoops
- NP347/2** Non-Slip Hoop Protector for Wood BD Hoops (pair)

P2050 SERIES CAMS



- P2050 SERIES CAMS**
- CAMPL** Eliminator Purple Cam, Aggressive Action
 - CAMYL** Eliminator Yellow Cam, Inverse Action
 - CAMTBK** Eliminator Translucent Black Cam, Linear Action
 - CAMTWT** Eliminator Translucent White Cam, Oversized Linear Action
 - CAMTBL** Eliminator Translucent Blue Cam, Progressive Action
 - CAMTRD** Eliminator Translucent Red Cam, Radical Action

FLOOR TOM LEGS & BRACKETS

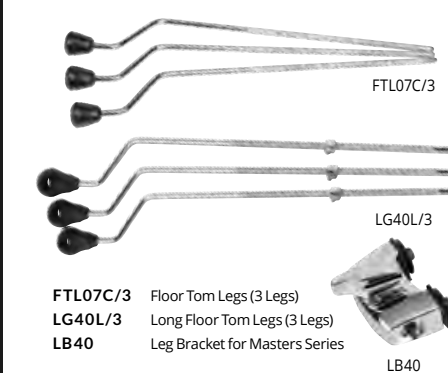

- FTL07C/3** Floor Tom Legs (3 Legs)
- LG40L/3** Long Floor Tom Legs (3 Legs)
- LB40** Leg Bracket for Masters Series

HI-HAT CLUTCHES & PARTS

RAPID LOCK HI-HAT CLUTCHES
Hi-Hat set-up and tear-down is a breeze with Rapid-Lock's Patented* two-point quick release locking system. *U.S. Patent #9355625

- HCL205DQR** Rapid Lock Quick Release Hi-Hat Drop Clutch w/ Locking Nut
- HCL205QR** Rapid Lock Quick Release Super Grip Hi-Hat Clutch w/ Locking Nut
- HCL105QR** Rapid Lock Quick Release Hi-Hat Clutch w/ Locking Nut
- HCL79** Hi-Hat Clutch Complete
- HHC90** Plastic Cup w/ Tilter



CHAINS & BELTS



- CCA5** Chain Assy Complete for Eliminator Pedals
- BCA250** Belt Assy Complete for P2050 Eliminator Pedals

SPRING



- SP64F** Spring for P930/P932

BEATERS & BEATER WEIGHTS



- DB100** Duo-Beater Felt/Plastic
- B250QB** Control Core Quad Beater
- BEATER WEIGHTS**
- BW100** Beater Weight, 3 Weights in One (U.S. Patent #7122730)

MASTERCAST HOOPS

MasterCast are the finest die cast hoops available and feature the perfect blend of thickness and mass to improve the depth, clarity, and focus of toms and snare drums.



Model #	Diameter	# of Tension
DC0805	8"	5
DC1006	10"	6
DC1206	12"	6
DC1306	13"	6
DC1408	14"	8
DC1408S	14"	8 Snare Side
DC1410	14"	10
DC1410S	14"	10 Snare Side
DC1410SG	14"	10 Snare Side w/Guard
DC1508	15"	8
DC1608	16"	8
DC1808	18"	8

SUPERHOOP II & FATTONE HOOPS

SuperHoop II hoops are precision formed from heavy-duty 2.3mm steel, triple-flanged and engraved with the SuperHoop II logo. FatTone hoops are low mass 1.6mm hoops with hemmed and welded edges for strength and rigidity.



Super Hoop Model #	FatTone Hoop Model #	Diameter	# of Tension
SH0604	NA	6"	4
SH0805	FH0805	8"	5
SH1006	FH1006	10"	6
SH1006S	NA	10"	6 Snare Side
SH1206	FH1206	12"	6
SH1208	NA	12"	8
SH1208S	NA	12"	8 Snare Side
SH1306	FH1306	13"	6
SH1308	FH1308	13"	8
SH1308S	FH1308S	13"	8 Snare Side
SH1408	FH1408	14"	8
SH1408S	NA	14"	8
SH1410B	FH1410	14"	10
SH1410S	FH1410S	14"	10 Snare Side
SH1410SG	NA	14"	10 Snare Side w/Guard
SH1508	FH1508	15"	8
SH1510S	NA	15"	10
SH1510B	NA	15"	10
SH1608	FH1608	16"	8
SH1808	FH1808	18"	8

STEEL HOOPS

Steel Hoop Model #	Diameter	# of Tension
RH0804	8"	4
RH1006	10"	6
RH1206	12"	6
RH1306	13"	6
RH1408	14"	8
RH1408S	14"	8 Snare side
RH1608	16"	8
RH1808	18"	8



BASS DRUM PEDAL TRAINING PAD

BD10
The BD10 bass pad is perfect for practicing at home or on the road. The wide pad accommodates double pedals and is specially formulated for extremely low noise and a realistic feel. The universal-fit "hoop" accepts all brands of pedals and adjusts to compensate for different floor surfaces. The BD10 folds for compact transport.

QUICK RELEASE WINGLOC

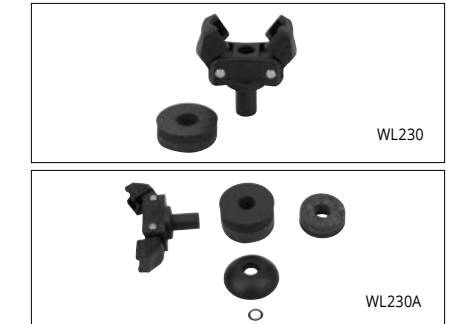

- WL230** Quick Release WingLoc
- WL230A** Quick Release WingLoc Complete

SEAT CUPS AND FELTS



- RC20** Reversible Seat Cup, w/ O-Ring
- PL011** Cymbal Seat Cup
- FLW001/2** Cymbal Felt Washer (2 Pieces)
- FLW003** Hi-Hat Cup Felt Washer

STOP LOCK



- ZD081A** Stop Lock Complete

DRUM KEYS



- KGT100** Gyro Tune Key w/ Quick Release
- K030** Hi-Tension Tuning Key
- K080** Tuning Key
- K180** Spin-Tight Key

AIR SUSPENSION FEET



- R40/3** Air Suspension Rubber Feet (3 Each)
- R5/3** Rubber Tip



MASTERS MAPLE GUM SHOWN WITH MASTERCAST HOOPS



MASTERS MAPLE COMPLETE SHOWN WITH SUPERHOOP II HOOPS

LUGS

- CL05** Lug for 3" Piccolo Snare
- CL50** Lug for 5" Deep Snare
- CL55** Lug for 5.5" Deep Snare
- CL65** Lug for 6.5" Deep Snare
- CL100** Lug for 7" Deep Snare



OPTI-LOC

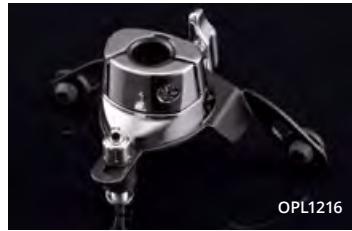

OPL1216

Opti-Loc suspension tom holders provide exceptional stability while greatly improving resonance and sustain. (For EXX / EXL Export / DMP)

- OPL0608/C Opti-Loc for EXX and DMP 6"-8" Diameter
- OPL1216/C Opti-Loc for EXX and DMP 12"-16" Diameter

JUNGLE GIG



JG16

JG16 • Pearl's Jungle Gig allows the conversion of a 16" Floor Tom to a Bass drum.

OPTIMOUNT

Our OptiMount Suspension System attaches to the tom's tension rods and floats on rubber cushions, providing the ultimate in stability while allowing the drum to resonate fully without restriction. With OptiMount, the mounting hardware is completely removed from the drum shell, providing a drastic improvement in resonance and sustain.



OPTA0708 OPTA0910 OPTA1112



OPT0708 OPT0910 OPT1112



OPT1314 OPT1516

- OPTA0708/C for drums 7"-8" deep, 6"-16" diameter, Light Weight Aluminum
- OPTA0910/C for drums 9"-10" deep, 6"-16" diameter, Light Weight Aluminum
- OPTA1112/C for drums 11"-12" deep, 6"-16" diameter, Light Weight Aluminum
- OPTA1314/C for drums 13"-14" deep, 6"-16" diameter, Light Weight Aluminum
- OPTA1516/C for drums 15"-16" deep, 6"-16" diameter, Light Weight Aluminum
- OPT0708 for drums 7"-8" deep, 8"-16" diameter, UltraGrip Wingnut
- OPT0910 for drums 9"-10" deep, 8"-16" diameter, UltraGrip Wingnut
- OPT1112 for drums 11"-12" deep, 8"-16" diameter, UltraGrip Wingnut
- OPT1314 for drums 13"-14" deep, 8"-16" diameter, UltraGrip Wingnut
- OPT1516 for drums 15"-16" deep, 8"-16" diameter, UltraGrip Wingnut

MUFFLERS

External clamp-on muffler for snare drums and toms. By adjusting the pressure and position of the felt pad, excessive overtones can be precisely controlled or eliminated.



OM1

- OM1 Clamp-on Muffler, Snare Drum & Toms

MUFFLE HEADS

Model #	Size	Model #	Size
MFH08	8"	MFH14	14"
MFH10	10"	MFH16	16"
MFH12	12"	MFH20B	20"
MFH13	13"	MFH22B	22"

BASS DRUM MUFFLER



BDMF

BDMM

- BDMF Bass Drum Muffler (Full Size)
- BDMM Bass Drum Muffler (Mini Size)

STRAINERS



SR017

- SR014N Standard Snare Strainer
- SR017 Snare Strainer Complete
- SR018 Snare Strainer Complete

TENSION ROD LOCKNUTS



- TNK10N/10 Tension Keeper (10/pkg)
- TL20/10 Tension Rod Lock Nuts (10/pkg)

TENSION ROD WASHERS



- NLW12B/12 Nylon Washers (12) Black
- MTW12/12 Metal Washers (12)

ULTRA-SOUND SNARES

Pearl's Ultra-Sound snares feature patented Graduated Tension wires for extended dynamic range from ultra soft to ultra loud. Ultra-thin, low mass end plates assure ultra quick response. The end plates feature three mounting options: tunnels or holes for cord mounting and slots for straps. U.S. Patent #7202405



- SN1320C 20 strands for 13", C-type, w/straps & cords
- SN1320D 20 strands for 13", D-type, w/straps & cords
- SN1320I 20 strands for 13", I-type, w/straps & cords
- SN1420C 20 strands for 14", C-type, w/straps & cords
- SN1420D 20 strands for 14", D-type, w/straps & cords
- SN1420I 20 strands for 14", I-type, w/straps & cords



- SN1442C 42 strands for 14", C-type, w/straps & cords
- SN1442D 42 strands for 14", D-type, w/straps & cords
- SN1442I 42 strands for 14", I-type, w/straps & cords

REPLACEMENT SNARES

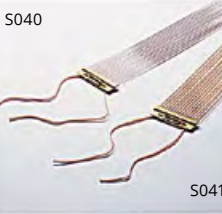

- S022N 20 Strand for 14" w/ Cords
- S022NU 20 Strand for 14" w/ Cords, Uncoated
- S022 20 Strand for 14" w/ Straps
- S025 20 Strand for 14" long, w/ Straps
- S029N 20 Strand for 13" w/ Cords
- S030N 24 Strand for 14" w/ Cords
- S031N 20 Strand for 12" w/ Cords
- S032N 12 Strand for 10" w/ Cords
- S033N 12 Strand for 12" w/ Cords
- S040 15 Strand for 14" w/ Cords, Steel Cable, Thinner Gauge
- S041 15 Strand for 14" w/ Cords, Bronze Cable, Thicker Gauge
- SPS18/6 Plastic Strap (6/pkg)
- SNC500R/4 Snare Cord (4/pkg)

SPIN-TIGHT™ TENSION RODS

Specially-designed stainless steel tension rods that lock to maintain tension settings. Starter pack includes 4 Spin-Tight Tension rods with K180 Drum Key.



- K180
- SPT5047 W7/32 x 47mm (1)
- SPT4SPK W7/32 x 47mm (4) w/ K180 Drum Key
- SPT6PK W7/32 x 47mm (6)

STAINLESS STEEL TENSION RODS

Pearl's Stainless Steel Tension Rods are machined, not forged, from a single piece of stainless steel to the most exacting tolerances in the industry. They feature super-smooth, precise tensioning, with absolutely no play. Each non-plated stainless steel tension rod is matched with a precision-machined brass swivel nut for ultra-precise performance.

- SST5028/6 W7/32 x 28mm (6)
- SST5035/6 W7/32 x 35mm (6)
- SST5038/6 W7/32 x 38mm (6)
- SST5042/6 W7/32 x 42mm (6)
- SST5047/6 W7/32 x 47mm (6)
- SST5052/6 W7/32 x 52mm (6)

TENSION RODS

- T055/6 W7/32 x 28mm (6) for 3" Deep Snare
- T060/6 W7/32 x 35mm (6) for Free Floaters before 2002
- T061/6 W7/32 x 42mm (6)
- T061L/6 W7/32 x 47mm (6) for 6.5" Deep Snare
- T062/6 W7/32 x 52mm (6) for 5.5" Deep Snare
- T065 M6 x 90mm (Bass Drum)
- T066 M6 x 115mm (Bass Drum)
- TR5052 W7/32 x 52mm (DMP, EXL, EXX, MDT Snare)
- TR5047 W7/32 x 47mm (DMP, EXL, EXX, MDT Toms)
- TR5100 W7/32 x 100mm (Bass Drum)





AARON SMITH INDEPENDENT



ADRIAN BENT DRAKE/DANIEL CAESAR



AREJAY HALE HALESTORM



ALVIN FORD ED O'BRIEN/TROMBONE SHORTY



BAARD KOLSTAD LEOPROUS



EDDIE BAYERS NASHVILLE LEGEND



ELISE TROUW ELISE TROUW



ERIC SINGER KISS



FLO MOUNIER CRYPTOPSY



FREDO ORTIZ GOGOL BORDELLO



BARRY KERCH SHINEDOWN



BEN GORDON PARKWAY DRIVE

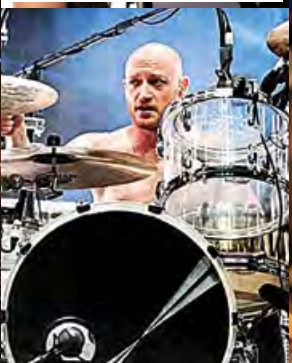

BEN JOHNSTON BIFFY CLYRO



BILLY HART JAZZ LEGEND



BRANDON PERTZBORN MARILYN MANSON



GARY HUSBAND INDEPENDENT



GENE HOGLAN TESTAMENT/DETHKLOK



GEORGE KOLLIAS NILE



HORACIO HERNANDEZ LATIN LEGEND



HUBERT PAYNE LITTLE BIG TOWN



BRANDON COMBS LEÓN BRIDGES/MARK DE CLIVE LOWE



BRIAN FRASIER-MOORE JUSTIN TIMBERLAKE



BRUNO VALVERDE ANGRA



CALVIN RODGERS INDEPENDENT



CASEY COOPER @COOP3DRUMM3R



IAN PAICE DEEP PURPLE



INFERNO BEHEMOTH



ISAAC TEEL TALK



JAMIE PERKINS THE PRETTY RECKLESS



JASON BITTNER OVERKILL



CHAD CROMWELL JOE WALSH/NEIL YOUNG



CHAD SEXTON 311



CHARLIE ENGEN FIVE FINGER DEATH PUNCH



CHRIS RALLES PAT BENATAR



DANA LAMARCA MAGGIE ROGERS



JASON BOWLD BULLET FOR MY VALENTINE



JASON HARTLESS TED NUGENT/STUDIO



JEFF MARINO DARIUS RUCKER



JEN LEDGER SKILLET/LEDGER



JERROD 'J-ROD' SULLIVAN THE 4 KORNERS



DAN PRESLAND NEOBLIVISCARIS



DANIEL ERLANDSSON ARCH ENEMY



DENA TAURIELLO BROADWAY



DENNIS CHAMBERS DRUMMING LEGEND



DESMOND DAVIS HUNTER HAYES



JESSIE CARABALLO MARC ANTHONY



JOCKE WALLGREN AMON AMARTH



JOE TOMINO MATISYAHU/DUB TRIO



JOEY JORDISON INDEPENDENT



JOEY KRAMER AEROSMITH



JOHN LONGSTRETH ORIGIN/HATE/ETERNAL



JOHN WICKS FITZ AND THE TANTRUMS



JON LARSEN VOLBEAT



JONATHAN MOVER INDEPENDENT



JOSH BAKER MARIAH CAREY



JUAN 'CARLITO' MENDOZA INDEPENDENT



KAI HAHTO NIGHTWISH



KEIO STROUD BIG AND RICH



KENWOOD DENNARD INDEPENDENT



KIKO FREITAS INDEPENDENT



KRIS MYERS UMPHREY'S MCGEE



LEE PEARSON CHRIS BOTTI



LENNY 'THE OX' REECE THE LESSON GK



LESTER ESTELLE KELLY CLARKSON/SESSIONS



MARCUS FINNIE MF BAND



MARVIN 'SMITTY' SMITH INDEPENDENT



MATT ABTS GOVT MULE



MATT HALPERN PERIPHERY



MATT MCGUIRE THE CHAINSMOKERS



MELVIN BALDWIN NEW EDITION/JOHNNY GILL



MICHAEL CARTELLONE LYNRYD SKYNYRD



MICHELLE BAPTISTE NORMANI/ADAM LAMBERT



MIGUEL LAMAS INDEPENDENT



MIKE MANGINI DREAM THEATER



MIKE WENGRIN DISTURBED



MORGAN ROSE SEVENDUST



NATE MORTON THE VOICE



OMAR HAKIM INDEPENDENT



PAUL KOEHLER SILVERSTEIN



PETE WEBBER HAVOK



QUINTON 'Q' ROBINSON AVERY'S SUNSHINE/ANTHONY DAVID



RAY LUZIER KORN



ROBBY AMEEN INDEPENDENT



RYAN MORAN SLIGHTLY STOOPID



SAM LOEFFLER CHEVELLE



SERGIO MELO THE VOICE BRAZIL



SHANE GAALAAS COSMOSQUAD



SHANNON FORREST TOTO/SESSIONS



SHAUN FOIST BREAKING BENJAMIN



TARON LOCKETT CORY HENRY AND THE FUNK APOSTLES



TAVARIUS JOHNSON LALAH HATHAWAY



TERRENCE HIGGINS WARREN HAYNES/ANI DI FRANCO



TODD SUCHERMAN STYX



TOM HURST INDEPENDENT



TONY PALERMO PAPA ROACH



TRACY BROUSSARD BLAKE SHELTON



TROY WRIGHT INDEPENDENT



TRAVIS ORBIN DARKEST HOUR



WILL HUNT EVANESCENCE



WILL KENNEDY YELLOWJACKETS

COLOR & CONFIGURATION CHART

MASTERS MAPLE RESERVE A CLASSIC FORMULA FOR SONIC GREATNESS.

PAGES 20 - 21



Masters Maple Reserve is available in all 36 Music City Custom special order finishes - see Page 19.
Also available in 28 Special Order Lacquer finishes - see Back Cover.

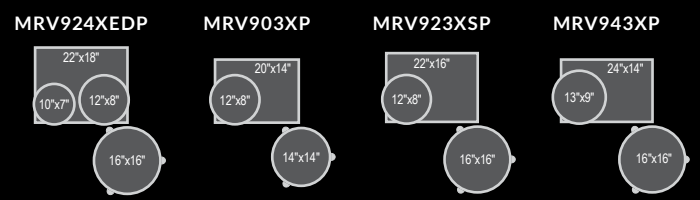

MASTERS MAPLE GUM THE EVOLUTION OF PREMIUM STUDIO TONE.

PAGES 22 - 23



Masters Maple Gum is available in all 36 Music City Custom special order finishes - see Page 19.
Also available in 28 Special Order Lacquer finishes - see Back Cover.

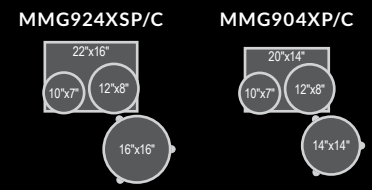

Added components in #186 can be special ordered.

MASTERS MAPLE COMPLETE AN ALL MAPLE DRUM SHELL FIT FOR THE MASTERS LEGACY.

PAGES 24 - 25

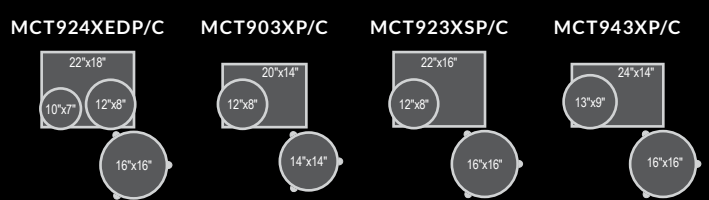

SESSION STUDIO SELECT A COMPLETELY NEW TAKE ON THE FULL SPECTRUM SOUND.

PAGES 26 - 27



HIGH GLOSS LACQUER
PREMIUM DELMAR WRAP

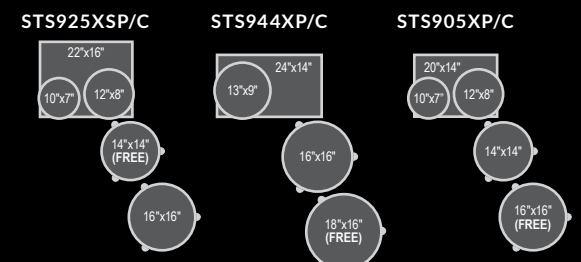

CRYSTAL BEAT THE ORIGINAL SEAMLESS ACRYLIC DRUM SHELL.

PAGES 28 - 29

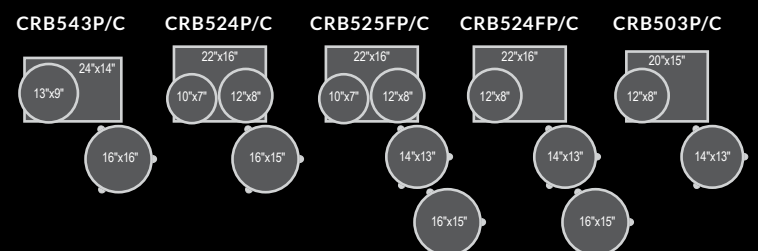

Individual components also available.
For sizes, visit www.pearldrums.com

COLOR & CONFIGURATION CHART

DECADE MAPLE A DRUM KIT 10 YEARS IN THE MAKING.

PAGES 30 - 31

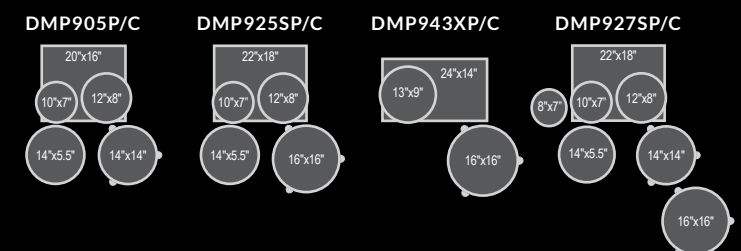

EXPORT LACQUER THE LEGENDS OF TOMORROW, PLAY EXPORT TODAY.

PAGE 32

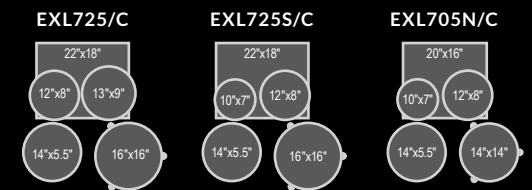

EXPORT THE BEST SELLING DRUM SET OF ALL TIME.

PAGE 33

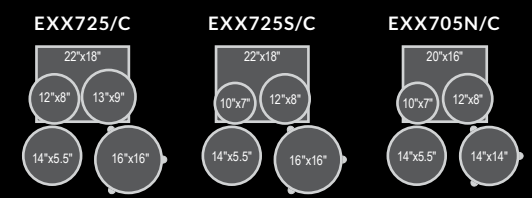

MIDTOWN BIG GIG, SMALL RIG, HUGE SOUND.

PAGE 34

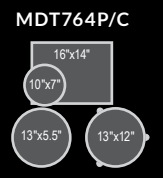

ROADSHOW IT'S YOUR TIME TO PLAY, START THE RIGHT WAY.

PAGE 35

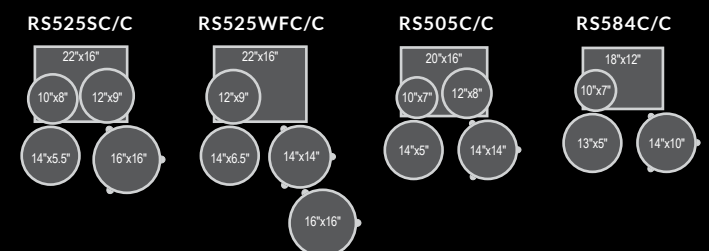

Pearl® SPECIAL ORDER LACQUER FINISHES

PAGES 12 - 15

CONFIGURATIONS:

REFERENCE
SONICALLY SELECT DRUM PERFORMANCE.

REFERENCE PURE
UNRESTRICTED TONAL RESPONSE.

RF924XEDP/C
RFP924XEDP/C

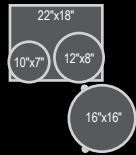

RF924XSP/C
RFP924XSP/C

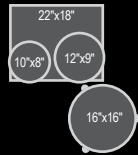

RF903XP/C
RFP903XP/C

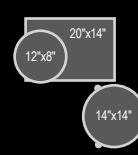

RF923XSP/C
RFP923XSP/C

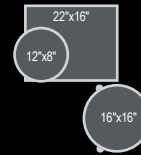

RF943XP/C
RFP943XP/C

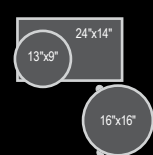

SPECIAL ORDER LACQUER FINISHES

AVAILABLE IN REFERENCE, REFERENCE PURE, MASTERS MAPLE RESERVE, AND MASTERS MAPLE GUM SERIES



#100 WINE RED



#102 NATURAL MAPLE



#103 PIANO BLACK



#109 ARCTIC WHITE



#142 ROOTBEER FADE



#143 TWILIGHT FADE



#155 SCARLET FADE



#197 RHYTHM BLUE



#302 INCA GOLD BURST



#329 BURNISHED
BRONZE SPARKLE



#330 IVORY PEARL



#334 RED METALLIC



#335 BLACK CHERRY



#342 VINTAGE
TOBACCO BURST



#345 SATIN AUBURN



#355 ANTIQUE WALNUT



#376 ULTRA BLUE FADE



#377 SCARLET
SPARKLE BURST



#393 PURPLE CRAZE II



#830 AUTUMN
FIRE SPARKLE



#831 MATTE
OLIVE BURST



#832 SAPPHIRE
BLUE SPARKLE



#833 EMERALD
SPARKLE



#834 GLACIER
BLUE SPARKLE



#835 AGED
HONEYBURST



#839 RED BURST
TRIBAND



#842 LIGHT AMBER



#844 SATIN
ROSE GOLD



THE BEST WARRANTY IN THE INDUSTRY! *

COMMITTED TO THE
HIGHEST LEVEL OF
CUSTOMER SATISFACTION.

The Pearl Lifetime Warranty is a statement of confidence to our customers to the reliability of Pearl products. Pearl drums, stands and hardware are designed and manufactured to the highest standards in quality, style, appearance and playing performance. This lifetime warranty reflects a tradition of excellence and a commitment to superior engineering and craftsmanship dedicated to you, the drummer. The Pearl lifetime warranty is our pledge to you that we will proudly stand behind our product for as long as you own it. *Buy it once, play it for life.*

- Drum Set/Concert wood and metal shells for the Lifetime of the Original Owner.
 - Foot pedals, hi-hat stands, cymbals stands, boom cymbal stands, snare drum stands, throne bases, floor-standing tom stands, floor-standing cymbal/ tom stands, concert stands, racks and rack accessories, cymbal holders and multi-clamps for the Lifetime of the Original Owner. Some exceptions apply.
 - Drum Set claws, tension rods, swivel nuts, spurs, tom brackets, tom holders, strainers, and nuts and bolts for the Lifetime of the Original Owner.
 - Rotationally molded cases for the Lifetime of the Original Owner.
 - The Lifetime Warranty applies to the aforementioned Pearl products purchased from June 15, 2009.
- * This Lifetime Warranty is valid only in the United States and excludes the Crystal Beat and Roadshow Series.

PEARL CORPORATION Corporate Headquarters
549 Metroplex Dr., P.O. Box 111240 Nashville, TN 37211-3140 | (615) 833-4477 FAX (615) 833-6242

WWW.PEARLDRUM.COM



pearldrumsfan



PearlDrumCorp



pearl_drums



PearlDrumCorp



pearldrumsforum.com